

Technical Catalogue

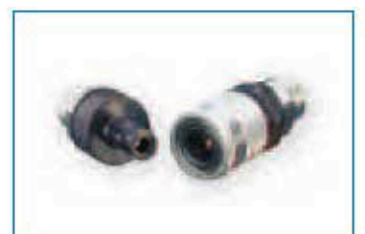

Nom. bore	Type	Max. static working pressure [bar/psi]			Min. burst pressure for steel [bar/psi]	C _v value		Cross section [mm ²]	Page
		steel	brass	st. st.		both sides self sealing	one side self sealing		
6	SG-006	250/3625	–	–	1400/20300	0.73	1.0	30	50 - 51
6	MD-006	200/2900	40/580	100/1450	1000/14500	0.73	–	30	52 - 53
7	MD-007	250/3625	40/580	100/1450	800/11600	1.07	–	40	54 - 55
12	MD-012	250/3625	40/580	100/1450	750/10900	3.25	–	120	56 - 57
19	MD-019	250/3625	40/580	50/725	750/10900	7.5	–	300	58 - 59
25	MD-025	220/3190	40/580	50/725	750/10900	13.5	–	490	60
32	MD-032	200/2900	40/580	40/580	700/10100	23.8	29.4	800	61 - 62
50	MD-050	100/1450	30/435	30/435	450/6500	59	68	2000	63 - 64
Performance diagrams									65 - 66

When determining the working pressure of the coupling the max. permissible working pressure of the end connection is to be taken into account if standardized threads are used. In case of pulsating pressure the use of HP-Series is recommended.

In stainless steel the version is partially smooth instead of knurled.

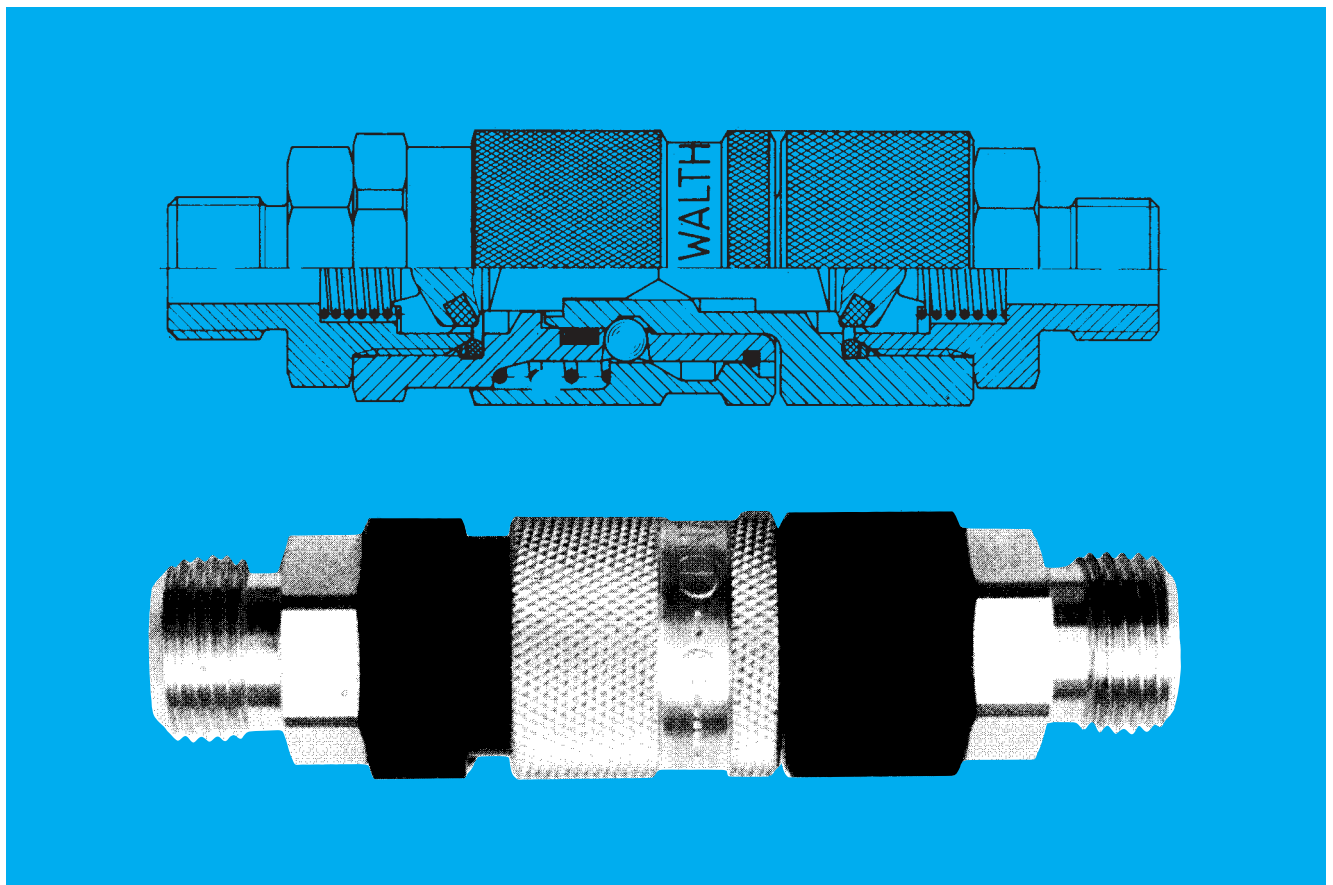

optional features:
OV = without valve

materials:
standard:
19 = steel zinc plated, partially oil burnished
12 = steel, oil burnished
(only valid for thru type adaptor)

seal qualities:
1 = NBR
2 = FPM
4 = EPDM

special materials:
13 = steel, chem. nickel plated

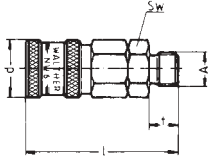
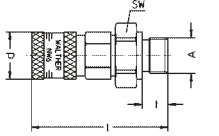
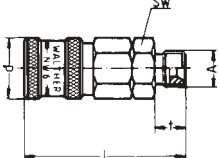
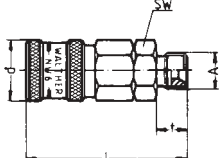
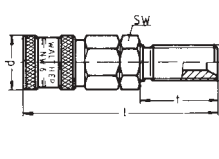
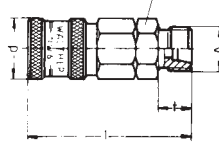
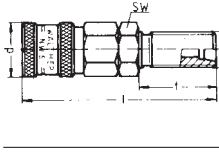
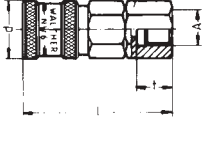

Please note the technical data on pages 2 - 7, 65 and the max. working pressures on page 49

Availability: ● Short ○ Medium ○ Long

	Part No.	Connec- tion A	steel zinc/ oil burn.	steel oil burnished			series	pipe OD	n. b.	d	SW	l	t	n	weight [g]
 <p>British standard pipe parallel (BSPP) male thread to DIN ISO 228</p>	SG-006-0-WR013-...-	BSPP 1/4"	●							22	19	58	11		90
	SG-006-0-WR017-...-	BSPP 3/8"	●							22	19	59	12		95
	SG-006-0-WR021-...-	BSPP 1/2"	●								22	22	62	15	
 <p>British standard pipe parallel (BSPP) male thread to DIN ISO 228, sealing profile "E" to DIN 3852-11 for o-ring or sealing ring.</p>	SG-006-0-WE017-...-	BSPP 3/8"	○							22	27	64	12		130
 <p>BSPP male thread to DIN ISO 228/BS 5200 with 60° sealing cone</p>	SG-006-0-VR013-...-	BSPP 1/4"	○						6	22	19	58	11		90
	SG-006-0-VR017-...-	BSPP 3/8"	○						6	22	19	59	12		95
 <p>metric male thread with 60° sealing cone to DIN 7631</p>	SG-006-0-D0614-...-	M 14 x 1,5	●						6	22	19	57	10		90
	 <p>metric male thread with 60° sealing cone to DIN 7631, extended thread for bulkhead mounting, max. thickness 10 mm</p>	SG-006-0-DV008-...-	M 14 x 1,5	○					6	22	19	79	32		110
 <p>metric male thread with 24° sealing cone to DIN 2353 (light duty series L, heavy duty series S)</p>	SG-006-0-L0612-...-	M 12 x 1,5	●			L	6	4	22	19	57	10		85	
	SG-006-0-L0814-...-	M 14 x 1,5	●			L	8	6	22	19	57	10		85	
	SG-006-0-L1016-...-	M 16 x 1,5	●			L	10	8	22	19	58	11		90	
	SG-006-0-L1218-...-	M 18 x 1,5	○			L	12	10	22	19	58	11		90	
	SG-006-0-S0816-...-	M 16 x 1,5	○			S	8	4	22	19	59	12		90	
	SG-006-0-S1018-...-	M 18 x 1,5	●			S	10	6	22	19	59	12		95	
SG-006-0-S1220-...-	M 20 x 1,5	○			S	12	8	22	22	59	12		100		
 <p>metric male thread with 24° sealing cone to DIN 2353 (light duty series L, heavy duty series S), extended thread, max. bulkhead thickness 10 mm</p>	SG-006-0-LV008-...-	M 14 x 1,5	○			L	8	6	22	19	79	32		110	
	SG-006-0-XX211-...-	M 16 x 1,5	○			L	10	8	22	19	79	32		120	
 <p>British standard pipe parallel (BSPP) female thread to DIN ISO 228</p>	SG-006-0-WR513-...-	BSPP 1/4"	●							22	19	57	13		95
	SG-006-0-WR517-...-	BSPP 3/8"	●							22	22	58	14		100

Self sealing couplings

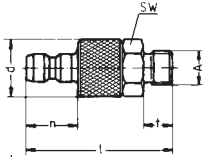
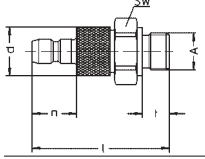
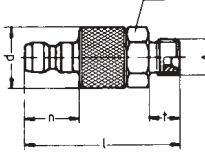
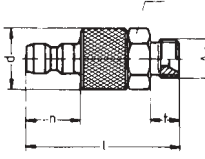
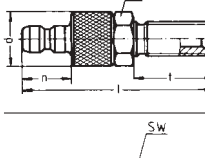
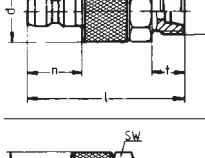
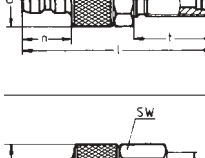
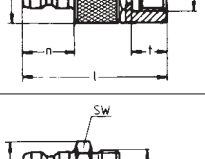
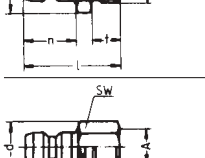
Availability: ● Short ● Medium ○ Long

		Part No.	Conne- tion A	steel zinc/ oil burn.	steel oil burnished			series	pipe OD	n. b.	d	SW	l	t	n	weight [g]	
Self sealing adaptors	 <p>British standard pipe parallel (BSPP) male thread to DIN ISO 228</p>	SG-006-2-WR013-...-.	BSPP 1/4"	●							22	19	56	11	20	70	
		SG-006-2-WR017-...-.	BSPP 3/8"	●								22	19	57	12	20	75
		SG-006-2-WR021-...-.	BSPP 1/2"	●								22	22	60	15	20	100
	 <p>British standard pipe parallel (BSPP) male thread to DIN ISO 228, sealing profile "E" to DIN 3852-11 for o-ring or sealing ring.</p>	SG-006-2-WE017-...-.	BSPP 3/8"	●							22	27	62	12	20	110	
		 <p>BSPP male thread to DIN ISO 228/BS 5200 with 60° sealing cone</p>	SG-006-2-VR013-...-.	BSPP 1/4"	○					6	22	19	56	11	20	70	
SG-006-2-VR017-...-.	BSPP 3/8"		○						6	22	19	57	12	20	75		
Thru type adaptors	 <p>metric male thread with 60° sealing cone to DIN 7631</p>	SG-006-2-D0614-...-.	M 14 x 1,5	●						6	22	19	55	10	20	70	
		SG-006-2-DV008-...-.	M 14 x 1,5	○						6	22	19	77	32	20	90	
	 <p>metric male thread with 60° sealing cone to DIN 7631, extended thread for bulkhead mounting, max. thickness 10 mm</p>	SG-006-2-L0612-...-.	M 12 x 1,5	●			L	6	4	22	19	55	10	20	70		
		SG-006-2-L0814-...-.	M 14 x 1,5	●			L	8	6	22	19	55	10	20	70		
		SG-006-2-L1016-...-.	M 16 x 1,5	●			L	10	8	22	19	56	11	20	75		
		SG-006-2-L1218-...-.	M 18 x 1,5	○			L	12	10	22	19	56	11	20	75		
		SG-006-2-S0816-...-.	M 16 x 1,5	○			S	8	4	22	19	57	12	20	75		
		SG-006-2-S1018-...-.	M 18 x 1,5	●			S	10	6	22	19	57	12	20	80		
	 <p>metric male thread with 60° sealing cone to DIN 7631, extended thread for bulkhead mounting, max. thickness 10 mm</p>	SG-006-2-S1220-...-.	M 20 x 1,5	○			S	12	8	22	22	57	12	20	85		
		 <p>metric male thread with 24° sealing cone to DIN 2353 (light duty series L, heavy duty series S), extended thread, max. bulkhead thickness 10 mm</p>	SG-006-2-LV008-...-.	M 14 x 1,5	○			L	8	6	22	19	77	32	20	90	
SG-006-2-XX211-...-.	M 16 x 1,5		○			L	10	8	22	19	77	32	20	100			
Thru type adaptors	 <p>British standard pipe parallel (BSPP) female thread to DIN ISO 228</p>	SG-006-2-WR513-...-.	BSPP 1/4"	●						22	19	55	13	20	75		
		SG-006-2-WR517-...-.	BSPP 3/8"	●							22	22	56	14	20	80	
		 <p>British standard pipe parallel (BSPP) male thread to DIN ISO 228</p>	SG-006-1-WR010-...-.	BSPP 1/8"	●							15,5	14	34	8	20	23
SG-006-1-WR013-...-.	BSPP 1/4"		●								19,6	14	37	11	20	26	
SG-006-1-WR017-...-.	BSPP 3/8"		●								21,9	19	38	12	20	37	
Thru type adaptors	 <p>British standard pipe parallel (BSPP) female thread to DIN ISO 228</p>	SG-006-1-WR513-...-.	BSPP 1/4"	●						19,6	17	36	13	20	26		
		SG-006-1-WR517-...-.	BSPP 3/8"	●							24	22	37	14	20	40	

characteristic features:
 - stainless steel version 1.4404/1.4571 or similar
 in smooth variant with gripping grooves instead of knurling

optional features:
 OV = without valve
 SI = with additional axial safety lock (outer diameter 29 mm)

materials:
standard:
 19 = steel zinc plated, partially oil burnished
 21 = brass, passivated
 01 = stainless steel 1.4404/1.4571 or similar

special materials:
 13 = steel, chem. nickel plated
 24 = brass, chem. nickel plated
 22 = brass, chrome plated

seal qualities:
 1 = NBR
 2 = FKM
 4 = EPDM

Please note the technical data on pages 2 - 7, 65 and the max. working pressures on page 49

Availability: ● Short ○ Medium ○ Long

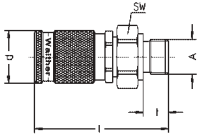
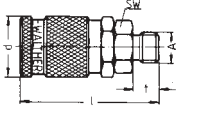
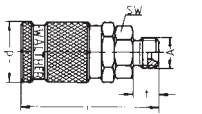
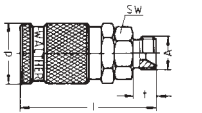
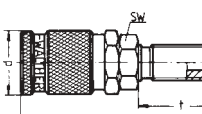
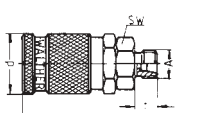
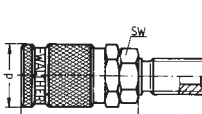
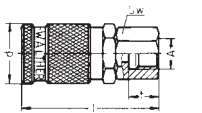
Part No.	Connec- tion A	steel zinc/ oil burn.	brass passivated	AISI 316 Ti/ 1.4571	series	pipe OD	n. b.	d	SW	l	t	n	weight [g]
 British standard pipe parallel (BSPP) male thread to DIN ISO 228, sealing profile "E" to DIN 3852-11 for o-ring or sealing ring. MD-006-0-WE017-...	BSPP 3/8"	●						25	27	64	12		157
 British standard pipe parallel (BSPP) male thread to DIN ISO 228 MD-006-0-WR013-... MD-006-0-WR017-... MD-006-0-WR021-...	BSPP 1/4"	●	●	○				25	19	58	11		110
	BSPP 3/8"	●	●	○				25	19	59	12		120
	BSPP 1/2"	●	●	○				25	22	62	15		140
 BSPP male thread to DIN ISO 228/BS 5200 with 60° sealing cone MD-006-0-VR013-... MD-006-0-VR017-...	BSPP 1/4"	○		○			6	25	19	58	11		110
	BSPP 3/8"	●		○			6	25	19	59	12		120
 metric male thread with 60° sealing cone to DIN 7631 MD-006-0-D0614-...	M 14 x 1,5	●		○			6	25	19	57	10		110
	 metric male thread with 60° sealing cone to DIN 7631, extended thread for bulkhead mounting, max. thickness 10 mm MD-006-0-DV008-...	M 14 x 1,5	○					6	25	19	79	32	
 metric male thread with 24° sealing cone to DIN 2353 (light duty series L, heavy duty series S) MD-006-0-L0612-... MD-006-0-L0814-... MD-006-0-L1016-... MD-006-0-L1218-... MD-006-0-S0816-... MD-006-0-S1018-... MD-006-0-S1220-...		M 12 x 1,5	●		○	L	6	4	25	19	57	10	
	M 14 x 1,5	●		○	L	8	6	25	19	57	10		110
	M 16 x 1,5	●		○	L	10	8	25	19	58	11		110
	M 18 x 1,5	○		○	L	12	10	25	19	58	11		110
	M 16 x 1,5	○		○	S	8	4	25	19	59	12		120
	M 18 x 1,5	●		○	S	10	6	25	19	59	12		120
	M 20 x 1,5	●		○	S	12	8	25	22	59	12		130
 metric male thread with 24° sealing cone to DIN 2353 (light duty series L, heavy duty series S), extended thread, max. bulkhead thickness 10 mm MD-006-0-LV008-... MD-006-0-XX211-...	M 14 x 1,5	○			L	8	6	25	19	79	32		130
	M 16 x 1,5	○			L	10	8	25	19	79	32		140
 British standard pipe parallel (BSPP) female thread to DIN ISO 228 MD-006-0-WR513-... MD-006-0-WR517-...	BSPP 1/4"	●	●	○				25	19	57	13		120
	BSPP 3/8"	●	●	○				25	22	58	14		130

Self sealing couplings

Availability: ● Short ● Medium ○ Long

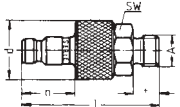
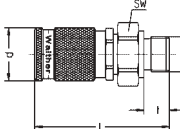
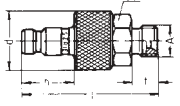
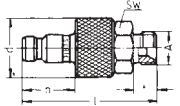
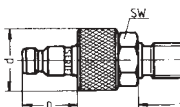
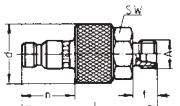
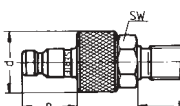
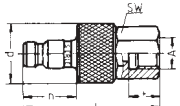
	Part No.	Conne- tion A	steel zinc/ oil burn.	brass passivated	AlSi 316 Ti/ 1.4571	series	pipe OD	n. b.	d	SW	l	t	n	weight [g]	
Self sealing adaptors	 <p>British standard pipe parallel (BSPP) male thread to DIN ISO 228</p>	MD-006-2-WR013-... MD-006-2-WR017-... MD-006-2-WR021-...	BSPP 1/4" BSPP 3/8" BSPP 1/2"	● ● ○	● ● ○	○ ○ ○			25 25 25	19 19 22	57,5 58,5 61,5	11 12 15	21,7 21,7 21,7	85 90 110	
		 <p>British standard pipe parallel (BSPP) male thread to DIN ISO 228, sealing profile "E" to DIN 3852-11 for o-ring or sealing ring.</p>	MD-006-2-WE017-...	BSPP 3/8"	○					25	27	63	12	21,7	127
		 <p>BSPP male thread to DIN ISO 228/BS 5200 with 60° sealing cone</p>	MD-006-2-VR013-... MD-006-2-VR017-...	BSPP 1/4" BSPP 3/8"	○ ○		○			6 6	25 25	19 19	57,5 58,5	11 12	21,7 21,7
	 <p>metric male thread with 60° sealing cone to DIN 7631</p>	MD-006-2-D0614-...	M 14 x 1,5	●		○			6	25	19	56,5	10	21,7	85
	 <p>metric male thread with 60° sealing cone to DIN 7631, extended thread for bulkhead mounting, max. thickness 10 mm</p>	MD-006-2-DV008-...	M 14 x 1,5	○					6	25	19	78,5	32	21,7	100
	 <p>metric male thread with 24° sealing cone to DIN 2353 (light duty series L, heavy duty series S)</p>	MD-006-2-L0612-... MD-006-2-L0814-... MD-006-2-L1016-... MD-006-2-L1218-... MD-006-2-S0816-... MD-006-2-S1018-... MD-006-2-S1220-...	M 12 x 1,5 M 14 x 1,5 M 16 x 1,5 M 18 x 1,5 M 16 x 1,5 M 18 x 1,5 M 20 x 1,5	● ● ● ○ ○ ● ●	○ ○ ○ ○ ○ ○ ○	L L L L S S S	6 8 10 12 8 10 12	4 6 8 10 4 6 8	25 25 25 25 25 25 25	19 19 19 19 19 19 22	56,5 56,5 57,5 57,5 58,5 58,5 58,5	10 10 11 11 12 12 12	21,7 21,7 21,7 21,7 21,7 21,7 21,7	85 85 85 85 90 90 100	
	 <p>metric male thread with 24° sealing cone to DIN 2353 (light duty series L, heavy duty series S), extended thread, max. bulkhead thickness 10 mm</p>	MD-006-2-LV008-... MD-006-2-XX211-...	M 14 x 1,5 M 16 x 1,5	○ ○			L L	8 10	6 8	25 25	19 19	78,5 78,5	32 32	21,7 21,7	100 110
	 <p>British standard pipe parallel (BSPP) female thread to DIN ISO 228</p>	MD-006-2-WR513-... MD-006-2-WR517-...	BSPP 1/4" BSPP 3/8"	● ●	● ●	○ ○			25 25	19 22	56,5 57,5	13 14	21,7 21,7	90 95	

Series MD

optional features:
 OV = without valve
 SI = with additional axial safety lock
 (outer diameter 34 mm)

materials:
 standard:
 19 = steel zinc plated, partially oil burnished
 21 = brass, passivated
 01 = stainless steel 1.4404/1.4571 or similar

seal qualities:
 1 = NBR
 2 = FKM
 4 = EPDM

special materials:
 13 = steel, chem. nickel plated
 24 = brass, chem. nickel plated
 22 = brass, chrome plated

Please note the technical data on pages 2 - 7, 65 and the max. working pressures on page 49

Availability: ● Short ○ Medium ○ Long

Self sealing couplings

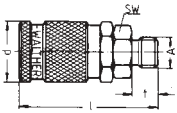
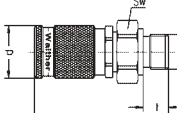
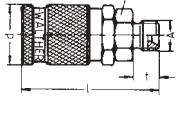
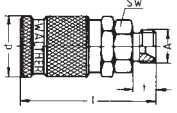
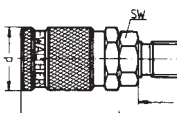
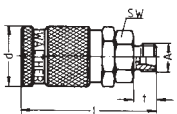
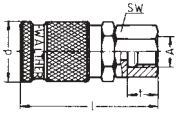
	Part No.	Connec- tion A	steel zinc/ oil burn.	brass passivated	AISI 316 ti/ 1.4571	series	pipe OD	n. b.	d	SW	l	t	n	weight [g]
 <p>British standard pipe parallel (BSPP) male thread to DIN ISO 228</p>	MD-007-0-WR017-... MD-007-0-WR021-...	BSPP 3/8" BSPP 1/2"	● ●	○ ○	○ ○				30 30	24 24	68 71	12 15		200 220
	 <p>British standard pipe parallel (BSPP) male thread to DIN ISO 228, sealing profile "E" to DIN 3852-11 for o-ring or sealing ring.</p>	MD-007-0-WE017-...	BSPP 3/8"	●					30	27	71	12		220
 <p>BSPP male thread to DIN ISO 228/BS 5200 with 60° sealing cone</p>	MD-007-0-VR017-...	BSPP 3/8"	○		○		7	30	24	68	12		210	
 <p>metric male thread with 60° sealing cone to DIN 7631</p>	MD-007-0-D0816-...	M 16 x 1,5	●		○		8	30	24	67	11		200	
 <p>metric male thread with 60° sealing cone to DIN 7631, extended thread for bulkhead mounting, max. thickness 10 mm</p>	MD-007-0-DV010-...	M 16 x 1,5	○				8	30	24	89,5	33,5		220	
 <p>metric male thread with 24° sealing cone to DIN 2353 (light duty series L, heavy duty series S)</p>	MD-007-0-L1016-... MD-007-0-L1218-... MD-007-0-S1018-... MD-007-0-S1220-...	M 16 x 1,5 M 18 x 1,5 M 18 x 1,5 M 20 x 1,5	● ○ ● ●		○ ○ ○ ○	L L S S	10 12 10 12	8 10 6 8	30 30 30 30	24 24 24 24	67 67 68 68	11 11 11 12		190 190 200 200
	 <p>British standard pipe parallel (BSPP) female thread to DIN ISO 228</p>	MD-007-0-WR517-... MD-007-0-WR521-...	BSPP 3/8" BSPP 1/2"	● ●	○ ○				30 30	24 27	68 71	14 17		210 230

Availability: ● Short ● Medium ○ Long

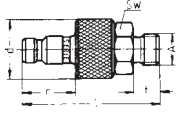
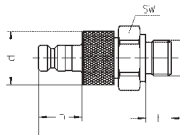
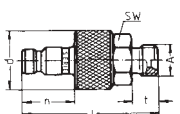
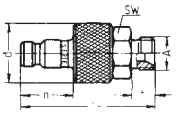
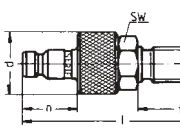
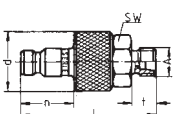
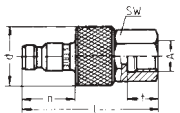
	Part No.	Conne- tion A	steel zinc/ oil burn.	brass passivated	AISI 316 Ti/ 1.4571	series	pipe OD	n. b.	d	SW	l	t	n	weight [g]
Self sealing adaptors	 <p>British standard pipe parallel (BSPP) male thread to DIN ISO 228</p>	MD-007-2-WR017-... MD-007-2-WR021-...	BSPP 3/8" BSPP 1/2"	● ●	● ●	○ ○			30 30	24 24	66,5 69,5	12 15	25 25	150 170
		 <p>British standard pipe parallel (BSPP) male thread to DIN ISO 228, sealing profile "E" to DIN 3852-11 for o-ring or sealing ring.</p>	MD-007-2-WE017-...	BSPP 3/8"	●	○	○			30	27	68	12	25
	 <p>BSPP male thread to DIN ISO 228/BS 5200 with 60° sealing cone</p>	MD-007-2-VR017-...	BSPP 3/8"	○	○	○			7 30	24	66,5	12	25	150
	 <p>metric male thread with 60° sealing cone to DIN 7631</p>	MD-007-2-D0816-...	M 16 x 1,5	●	○	○			8 30	24	66,5	11	25	140
	 <p>metric male thread with 60° sealing cone to DIN 7631, extended thread for bulkhead mounting, max. thickness 10 mm</p>	MD-007-2-DV010-...	M 16 x 1,5	○	○	○			8 30	24	88	33,5	25	170
	 <p>metric male thread with 24° sealing cone to DIN 2353 (light duty series L, heavy duty series S)</p>	MD-007-2-L1016-... MD-007-2-L1218-... MD-007-2-S1018-... MD-007-2-S1220-...	M 16 x 1,5 M 18 x 1,5 M 18 x 1,5 M 20 x 1,5	● ○ ● ●	○ ○ ○ ○	○ ○ ○ ○	L L S S	10 12 10 12	8 30 10 30 6 30 8 30	24 24 24 24	65,5 65,5 66,5 66,5	11 11 12 12	25 25 25 25	150 150 160 160
	 <p>British standard pipe parallel (BSPP) female thread to DIN ISO 228</p>	MD-007-2-WR517-... MD-007-2-WR521-...	BSPP 3/8" BSPP 1/2"	● ●	● ●	○ ○			30 30	24 27	66,5 69,5	14 15	25 25	160 180

optional features:
 OV = without valve
 SI = with additional axial safety lock
 (outer diameter 44 mm)

materials:
 standard:
 19 = steel zinc plated, partially oil burnished
 21 = brass, passivated
 01 = stainless steel 1.4404/1.4571 or similar

seal qualities:
 1 = NBR
 2 = FKM
 4 = EPDM

special materials:
 13 = steel, chem. nickel plated
 24 = brass, chem. nickel plated
 22 = brass, chrome plated

Please note the technical data on pages 2 - 7, 65 and the max. working pressures on page 49

Availability: ● Short ○ Medium ○ Long

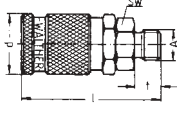
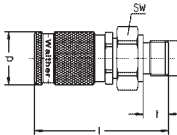
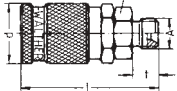
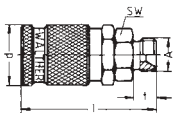
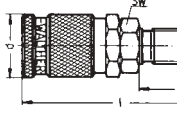
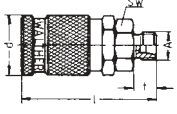
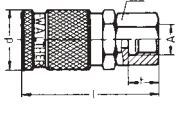
	Part No.	Connec- tion A	steel zinc/ oil burn.	brass passivated	AISI 316 Ti/ 1.4571	series	pipe OD	n. b.	d	SW	l	t	n	weight [g]
 <p>British standard pipe parallel (BSPP) male thread to DIN ISO 228</p>	MD-012-0-WR021-...-	BSPP 1/2"	●	○	○				40	32	82	15		390
	MD-012-0-WR026-...-	BSPP 3/4"	●	○	○				40	32	84	17		420
	MD-012-0-WR033-...-	BSPP 1"	●	○	○				40	36	88	20		480
 <p>British standard pipe parallel (BSPP) male thread to DIN ISO 228, sealing profile "E" to DIN 3852-11 for o-ring or sealing ring.</p>	MD-012-0-WE021-...-	BSPP 1/2"	○	○	○				40	32	84	14		400
 <p>BSPP male thread to DIN ISO 228/BS 5200 with 60° sealing cone</p>	MD-012-0-VR021-...-	BSPP 1/2"	●	○	○			12	40	32	82	15		390
	MD-012-0-VR026-...-	BSPP 3/4"	○	○	○			12	40	32	84	17		410
 <p>metric male thread with 60° sealing cone to DIN 7631</p>	MD-012-0-D1018-...-	M 18 x 1,5	○	○	○			10	40	32	78	11		380
	MD-012-0-D1222-...-	M 22 x 1,5	○	○	○			12	40	32	79	12		390
 <p>metric male thread with 60° sealing cone to DIN 7631, extended thread for bulkhead mounting, max. thickness 10 mm</p>	MD-012-0-DV015-...-	M 22 x 1,5	○	○	○			13	40	32	106	39		440
 <p>metric male thread with 24° sealing cone to DIN 2353 (light duty series L, heavy duty series S)</p>	MD-012-0-L1218-...-	M 18 x 1,5	●	○	○	L	12	10	40	32	78	11		380
	MD-012-0-L1522-...-	M 22 x 1,5	●	○	○	L	15	12	40	32	79	12		390
	MD-012-0-S1624-...-	M 24 x 1,5	●	○	○	S	16	12	40	32	81	14		400
 <p>British standard pipe parallel (BSPP) female thread to DIN ISO 228</p>	MD-012-0-WR521-...-	BSPP 1/2"	●	○	○				40	32	81	17		430
	MD-012-0-WR526-...-	BSPP 3/4"	●	○	○				40	32	83	19		410

Self sealing couplings

Availability: ● Short ● Medium ○ Long

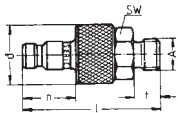
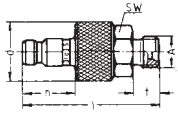
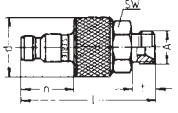
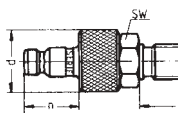
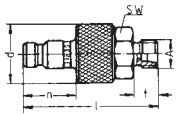
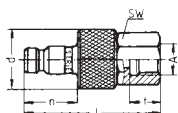
	Part No.	Conne- tion A	steel zinc/ oil burn.	brass passivated	AISI 316 Ti/ 1.4571	series	pipe OD	n. b.	d	SW	l	t	n	weight [g]	
Self sealing adaptors	 <p>British standard pipe parallel (BSPP) male thread to DIN ISO 228</p>	MD-012-2-WR021-... MD-012-2-WR026-... MD-012-2-WR033-...	BSPP 1/2" BSPP 3/4" BSPP 1"	● ● ○	● ● ○	○ ○ ○			40 40 40	32 32 36	82 84 88	15 17 20	31,5 31,5 31,5	300 330 390	
		MD-012-2-WE021-...	BSPP 1/2"	●					40	32	84	14	31,5	310	
		MD-012-2-VR021-... MD-012-2-VR026-...	BSPP 1/2" BSPP 3/4"	● ○		○ ○			12 12	40 40	32 32	82 84	15 17	31,5 31,5	300 320
	 <p>BSPP male thread to DIN ISO 228/BS 5200 with 60° sealing cone</p>	MD-012-2-D1018-... MD-012-2-D1222-...	M 18 x 1,5 M 22 x 1,5	● ●		○			10 12	40 40	32 32	78 79	11 12	31,5 31,5	290 300
	 <p>metric male thread with 60° sealing cone to DIN 7631</p>	MD-012-2-DV015-...	M 22 x 1,5	○					13	40	32	106	39	31,5	350
	 <p>metric male thread with 60° sealing cone to DIN 7631, extended thread for bulkhead mounting, max. thickness 10 mm</p>	MD-012-2-L1218-... MD-012-2-L1522-... MD-012-2-S1624-...	M 18 x 1,5 M 22 x 1,5 M 24 x 1,5	● ● ●		○ ○ ○	L L S	12 15 16	10 12 12	40 40 40	32 32 32	78 79 81	11 12 14	31,5 31,5 31,5	290 300 310
	 <p>metric male thread with 24° sealing cone to DIN 2353 (light duty series L, heavy duty series S)</p>	MD-012-2-WR521-... MD-012-2-WR526-...	BSPP 1/2" BSPP 3/4"	● ●	● ●	○ ○			40 40	32 32	81 83	17 19	31,5 31,5	340 320	
	 <p>British standard pipe parallel (BSPP) female thread to DIN ISO 228</p>														

Series MD

optional features:
 GG = with ring grips (cast aluminium)
 OV = without valve
 SI = with additional axial safety lock (outer diameter 58 mm)

materials:
standard:
 19 = steel zinc plated, partially oil burnished
 21 = brass, passivated
 01 = stainless steel 1.4404/1.4571 or similar

seal qualities:
 1 = NBR
 2 = FKM
 4 = EPDM

special materials:
 13 = steel, chem. nickel plated
 24 = brass, chem. nickel plated
 22 = brass, chrome plated

Please note the technical data on pages 2 - 7, 65 and the max. working pressures on page 49

Availability: ● Short ○ Medium ○ Long

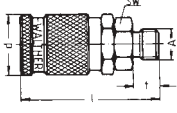
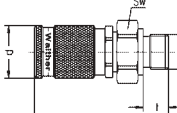
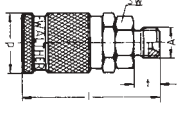
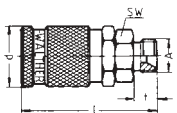
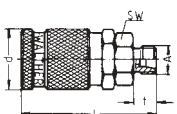
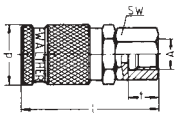
	Part No.	Connec- tion A	steel zinc/ oil burn.	brass passivated	AISI 316 Ti/ 1.4571	series	pipe OD	n. b.	d	SW	l	t	n	weight [g]	
Self sealing couplings	 <p>British standard pipe parallel (BSPP) male thread to DIN ISO 228</p>	MD-019-0-WR026-... MD-019-0-WR033-...	BSPP 3/4" BSPP 1"	● ●	○ ○				54 54	46 46	100 103	17 20		840 870	
		 <p>British standard pipe parallel (BSPP) male thread to DIN ISO 228, sealing profile "E" to DIN 3852-11 for o-ring or sealing ring.</p>	MD-019-0-WE026-...	BSPP 3/4"	●					54	46	102	16		850
	 <p>BSPP male thread to DIN ISO 228/BS 5200 with 60° sealing cone</p>	MD-019-0-VR026-... MD-019-0-VR033-...	BSPP 3/4" BSPP 1"	● ●	○ ○			19 19	54 54	46 46	100 103	17 20		850 880	
		 <p>metric male thread with 60° sealing cone to DIN 7631</p>	MD-019-0-D1526-... MD-019-0-D1930-...	M 26 x 1,5 M 30 x 1,5	● ●	○ ○			15 19	54 54	46 46	95 97	12 14		830 830
	 <p>metric male thread with 60° sealing cone to DIN 7631, extended thread for bulkhead mounting, max. thickness 10 mm</p>	MD-019-0-DV022-...	M 30 x 1,5	○				19	54	46	128	45		920	
	 <p>metric male thread with 24° sealing cone to DIN 2353 (light duty series L, heavy duty series S)</p>	MD-019-0-L1826-... MD-019-0-L2230-... MD-019-0-S2030-... MD-019-0-S2536-...	M 26 x 1,5 M 30 x 2 M 30 x 2 M 36 x 2	● ● ● ●	○ ○ ○ ○		L L S S	18 22 20 25	16 20 16 20	54 54 54 54	46 46 46 46	95 97 99 101	12 14 16 18		830 830 850 870
		 <p>British standard pipe parallel (BSPP) female thread to DIN ISO 228</p>	MD-019-0-WR526-... MD-019-0-WR533-...	BSPP 3/4" BSPP 1"	● ●	○ ○				54 54	46 46	94 98	19 23		900 880

Availability: ● Short ● Medium ○ Long

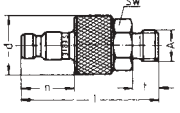
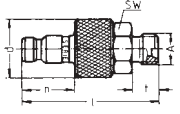
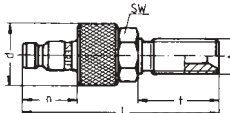
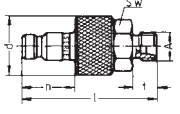
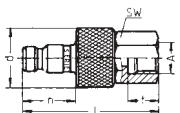
	Part No.	Conne- tion A	steel zinc/ oil burn.	brass passivated	AISI 316 Ti/ 1.4571	series	pipe OD	n. b.	d	SW	l	t	n	weight [g]							
Self sealing adaptors	 <p>British standard pipe parallel (BSPP) male thread to DIN ISO 228</p>	MD-019-2-WR026-... MD-019-2-WR033-...	BSPP 3/4" BSPP 1"	● ●	● ●	○ ○									54 54	46 46	99 102	17 20	35,5 35,5	710 740	
		MD-019-2-WE026-...	BSPP 3/4"	●												54	46	101	16	35,5	720
	 <p>BSPP male thread to DIN ISO 228/BS 5200 with 60° sealing cone</p>	MD-019-2-VR026-... MD-019-2-VR033-...	BSPP 3/4" BSPP 1"	● ●		○ ○			19 19	54 54	46 46	99 102	17 20	35,5 35,5	710 740						
		MD-019-2-D1526-... MD-019-2-D1930-...	M 26 x 1,5 M 30 x 1,5	● ●		○ ○			15 19	54 54	46 46	94 96	12 14	35,5 35,5	700 700						
	 <p>metric male thread with 60° sealing cone to DIN 7631, extended thread for bulkhead mounting, max. thickness 10 mm</p>	MD-019-2-DV022-...	M 30 x 1,5	○					19	54	46	127	45	35,5	790						
	 <p>metric male thread with 24° sealing cone to DIN 2353 (light duty series L, heavy duty series S)</p>	MD-019-2-L1826-... MD-019-2-L2230-... MD-019-2-S2030-... MD-019-2-S2536-...	M 26 x 1,5 M 30 x 2 M 30 x 2 M 36 x 2	● ● ● ●		○ ○ ○ ○	L L S S	18 22 20 25	16 20 16 20	54 54 54 54	46 46 46 46	94 96 98 100	12 14 16 18	35,5 35,5 35,5 35,5	700 700 720 740						
		 <p>British standard pipe parallel (BSPP) female thread to DIN ISO 228</p>	MD-019-2-WR526-... MD-019-2-WR533-...	BSPP 3/4" BSPP 1"	● ●	● ●	○ ○									54 54	46 46	93 97	19 23	35,5 35,5	770 750

Series MD

characteristic features:
 - stainless steel version 1.4404/1.4571 or similar
 in smooth variant with gripping grooves instead
 knurling

optional features:
 GG = with ring grips (cast aluminium)
 OV = without valve
 SI = with additional axial safety lock
 (outer diameter 58 mm)

materials:
standard:
 19 = steel zinc plated, partially oil burnished
 21 = brass, passivated
 01 = stainless steel 1.4404/1.4571 or similar

special materials:
 13 = steel, chem. nickel plated
 24 = brass, chem. nickel plated
 22 = brass, chrome plated

seal qualities:
 1 = NBR
 2 = FPM
 4 = EPDM

Please note the
 technical data on
 pages 2 - 7, 65 and the
 max. working pressures
 on page 49

Availability: ● Short ○ Medium ○ Long

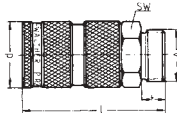
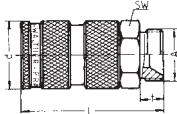
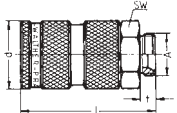
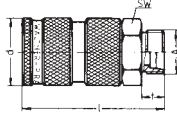
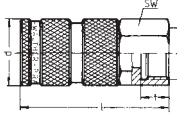
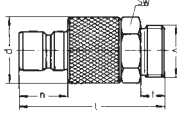
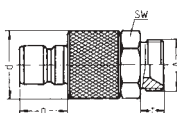
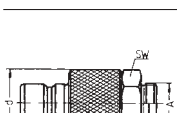
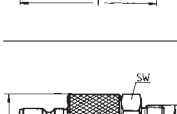
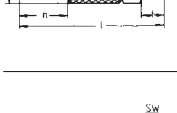
	Part No.	Connec- tion A	steel zinc/ oil burn.	brass passivated	AISI 316 Ti/ 1.4571	series	pipe OD	n. b.	d	SW	l	t	n	weight [g]	
Self sealing couplings	 British standard pipe parallel (BSPP) male thread to DIN ISO 228	MD-025-0-WR048-...	BSPP 1 1/2"	●	○	○			62	55	132	22		1710	
	 BSPP male thread to DIN ISO 228/BS 5200 with 60° sealing cone	MD-025-0-VR048-...	BSPP 1 1/2"	●		○			62	55	132	22		1640	
	 metric male thread with 60° sealing cone to DIN 7631	MD-025-0-D2538-...	M 38 x 1,5	●		○			25	62	55	124	14	1650	
	 metric male thread with 24° sealing cone to DIN 2353 (light duty series L, heavy duty series S)	MD-025-0-S3042-...	M 42 x 2	●		○	S	30	25	62	55	130	20	1610	
	 British standard pipe parallel (BSPP) female thread to DIN ISO 228	MD-025-0-WR548-...	BSPP 1 1/2"	●	○	○				62	55	138,5	25	1740	
Self sealing adaptors	 British standard pipe parallel (BSPP) male thread to DIN ISO 228	MD-025-2-WR048-...	BSPP 1 1/2"	●	○	○			62	55	133	22	45	1370	
	 BSPP male thread to DIN ISO 228/BS 5200 with 60° sealing cone	MD-025-2-VR048-...	BSPP 1 1/2"	●		○			62	55	133	22	45	1300	
	 metric male thread with 60° sealing cone to DIN 7631	MD-025-2-D2538-...	M 38 x 1,5	●		○			25	62	55	125	14	45	1310
	 metric male thread with 24° sealing cone to DIN 2353 (light duty series L, heavy duty series S)	MD-025-2-S3042-...	M 42 x 2	●		○	S	30	25	62	55	131	20	45	1280
	 British standard pipe parallel (BSPP) female thread to DIN ISO 228	MD-025-2-WR548-...	BSPP 1 1/2"	●	○	○				62	55	139,5	25	45	1400

optional features:
 GG = with ring grips (cast aluminium)
 OV = without valve
 SI = with additional axial safety lock
 (outer diameter 89 mm)

materials:
standard:
 19 = steel zinc plated, partially oil burnished
 21 = brass, passivated
 01 = stainless steel 1.4404/1.4571 or similar

seal qualities:
 1 = NBR
 2 = FKM
 4 = EPDM

special materials:
 13 = steel, chem. nickel plated
 24 = brass, chem. nickel plated
 22 = brass, chrome plated
 31 = aluminium anodized silver

Please note the technical data on pages 2 - 7, 65 and the max. working pressures on page 49

Availability: ● Short ● Medium ○ Long

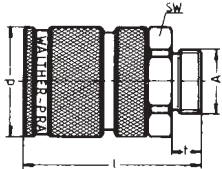
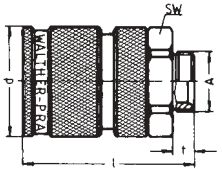
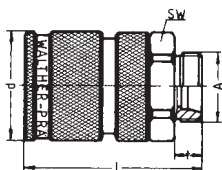
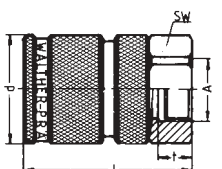
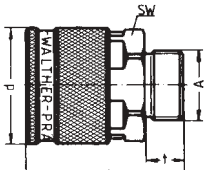
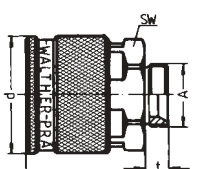
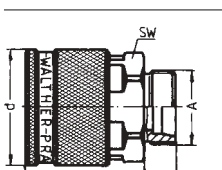
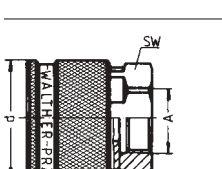
	Part No.	Conne- tion A	steel zinc/ oil burn.	brass passivated	AISI 316 Ti/ 1.4571	series	pipe OD	n. b.	d	SW	l	t	n	weight [g]
Self sealing couplings	 British standard pipe parallel (BSPP) male thread to DIN ISO 228 MD-032-0-WR048-...- MD-032-0-WR060-...-	BSPP 1 1/2"	●	●	○				82	75	139	22		3080
		BSPP 2"	○	○	○				82	75	143	26		3290
	 metric male thread with 60° sealing cone to DIN 7631 MD-032-0-D3245-...-	M 45 x 1,5	○	○	○			32	82	75	128	16		2880
		 metric male thread with 24° sealing cone to DIN 2353 (light duty series L, heavy duty series S) MD-032-0-S3852-...-	M 52 x 2	●	○	○	S	38	32	82	75	134	22	
 British standard pipe parallel (BSPP) female thread to DIN ISO 228 MD-032-0-WR548-...- MD-032-0-WR560-...-	BSPP 1 1/2"		●	●	○				82	75	126	25		3050
	BSPP 2"	●	●	○				82	75	130	29		2920	
Thru type couplings	 British standard pipe parallel (BSPP) male thread to DIN ISO 228 MD-032-4-WR048-...- MD-032-4-WR060-...-	BSPP 1 1/2"	○	○	○				82	70	110	23		2190
		BSPP 2"	○	○	○				82	70	113	26		2390
	 metric male thread with 60° sealing cone to DIN 7631 MD-032-4-D3245-...-	M 45 x 1,5	○	○	○			32	82	70	103	16		2140
		 metric male thread with 24° sealing cone to DIN 2353 (light duty series L, heavy duty series S) MD-032-4-S3852-...-	M 52 x 2	○	○	○	S	38	32	82	70	109	22	
 British standard pipe parallel (BSPP) female thread to DIN ISO 228 MD-032-4-WR548-...- MD-032-4-WR560-...-	BSPP 1 1/2"		○	○	○				82	70	87	25		1890
	BSPP 2"	○	○	○				82	70	87	27		1700	

optional features:
OV = without valve

materials:
standard:
19 = steel zinc plated, partially oil burnished
21 = brass, passivated
01 = stainless steel 1.4404/1.4571 or similar
12 = steel, oil burnished
special materials:
13 = steel, chem. nickel plated
24 = brass, chem. nickel plated
22 = brass, chrome plated
31 = aluminium anodized silver

seal qualities:
1 = NBR
2 = FKM
4 = EPDM

Please note the technical data on pages 2 - 7, 65 and the max. working pressures on page 49

Availability: ● Short ○ Medium ○ Long

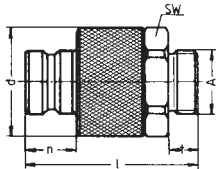
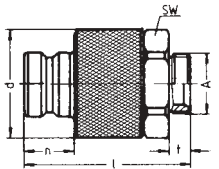
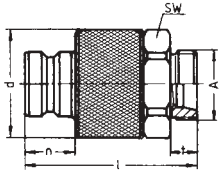
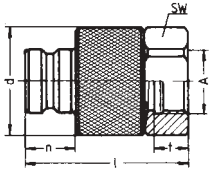
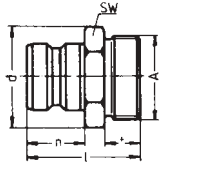
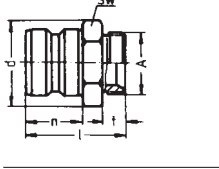
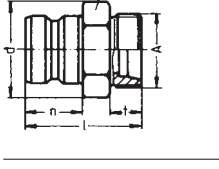
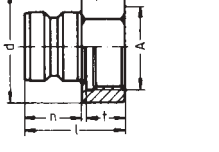
	Part No.	Connec- tion A	steel zinc/ oil burn.	brass passivated	AISI 316 ti/ 1.4571	steel oil burnished	series	pipe OD	n. b.	d	SW	l	t	n	weight [g]	
			○	●	○	○										
Self sealing adaptors	 <p>British standard pipe parallel (BSPP) male thread to DIN ISO 228</p>	MD-032-2-WR048-... MD-032-2-WR060-...	BSPP 1 1/2" BSPP 2"	●	●	○				82	75	137,5	22	41	2600	
				○	○	○			82	75	141,5	26	41	2810		
	 <p>metric male thread with 60° sealing cone to DIN 7631</p>	MD-032-2-D3245-...	M 45 x 1,5	○						32	82	75	126,5	16	41	2400
Thru type adaptors	 <p>metric male thread with 24° sealing cone to DIN 2353 (light duty series L, heavy duty series S)</p>	MD-032-2-S3852-...	M 52 x 2	●				S	38	32	82	75	132,5	22	41	2460
	 <p>British standard pipe parallel (BSPP) female thread to DIN ISO 228</p>	MD-032-2-WR548-... MD-032-2-WR560-...	BSPP 1 1/2" BSPP 2"	●	●	○				82	75	124,5	25	41	2570	
				●	●	○			82	75	128,5	29	41	2440		
Thru type adaptors	 <p>British standard pipe parallel (BSPP) male thread to DIN ISO 228</p>	MD-032-1-WR048-... MD-032-1-WR060-...	BSPP 1 1/2" BSPP 2"		○	○	○			60	55	82	22	41	620	
					○	○	○			72,5	65	88	26	41	670	
	 <p>metric male thread with 60° sealing cone to DIN 7631</p>	MD-032-1-D3245-...	M 45 x 1,5		○	○	○			32	61,3	55	70,5	16	41	510
 <p>metric male thread with 24° sealing cone to DIN 2353 (light duty series L, heavy duty series S)</p>	MD-032-1-S3852-...	M 52 x 2		○	○	○	S	38	32	66,9	60	82	22	41	630	
 <p>British standard pipe parallel (BSPP) female thread to DIN ISO 228</p>	MD-032-1-WR548-... MD-032-1-WR560-...	BSPP 1 1/2" BSPP 2"		○	○	○			66	60	75	25	41	700		
				○	○	○			78	70	77	27	41	820		

optional features:
 GG = with ring grips (cast aluminium)
 OV = without valve
 SI = with additional axial safety lock
 (outer diameter 116 mm)

materials:
standard:
 19 = steel zinc plated, partially oil burnished
 21 = brass, passivated
 01 = stainless steel 1.4404/1.4571 or similar

seal qualities:
 1 = NBR
 2 = FKM
 4 = EPDM

special materials:
 13 = steel, chem. nickel plated
 24 = brass, chem. nickel plated
 22 = brass, chrome plated
 31 = aluminium anodized silver

Please note the technical data on pages 2 - 7, 65 and the max. working pressures on page 49

Availability: ● Short ● Medium ○ Long

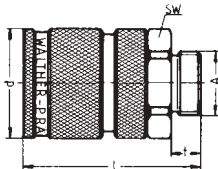
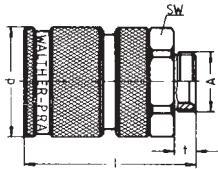
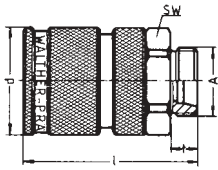
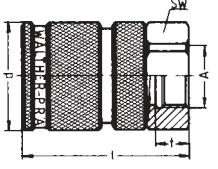
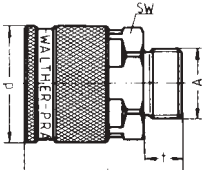
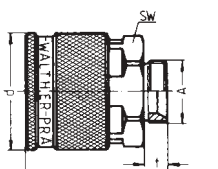
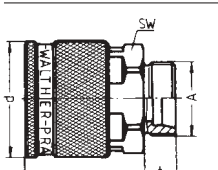
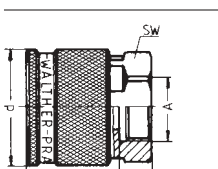
	Part No.	Conne- tion A	steel zinc/ oil burn.	brass passivated	AISI 316 Ti/ 1.4571	series	pipe OD	n. b.	d	SW	l	t	n	weight [g]	
			○	○	○										
Self sealing couplings	 British standard pipe parallel (BSPP) male thread to DIN ISO 228 MD-050-0-WR060-... MD-050-0-WR075-...	BSPP 2"	●	○	○				112	100	162	26		5530	
		BSPP 2 1/2"			○				112	100	164	30		5540	
	 metric male thread with 60° sealing cone to DIN 7631 MD-050-0-D4965-...	M 65 x 2							49	112	100	159	18		5460
		 metric male thread with 24° sealing cone to DIN 2353 (light duty series L, heavy duty series S) MD-050-0-L4252-...	M 52 x 2		○		L	42	36	112	100	158	16		5410
 British standard pipe parallel (BSPP) female thread to DIN ISO 228 MD-050-0-WR560-... MD-050-0-WR575-...	BSPP 2"		●	○	○				112	100	158	29		6140	
		BSPP 2 1/2"	○	○	○				112	100	167	33		5930	
Thru type couplings	 British standard pipe parallel (BSPP) male thread to DIN ISO 228 MD-050-4-WR060-... MD-050-4-WR075-...	BSPP 2"	○	○	○				112	100	132,5	26		4090	
		BSPP 2 1/2"	○	○	○				112	100	137,5	30		4340	
	 metric male thread with 60° sealing cone to DIN 7631 MD-050-4-D4965-...	M 65 x 2							49	112	100	125,5	18		3980
		 metric male thread with 24° sealing cone to DIN 2353 (light duty series L, heavy duty series S) MD-050-4-L4252-...	M 52 x 2				L	42	36	112	100	122	16		3920
 British standard pipe parallel (BSPP) female thread to DIN ISO 228 MD-050-4-WR560-... MD-050-4-WR575-...	BSPP 2"		○	○	○				112	100	112	29		4600	
		BSPP 2 1/2"	○	○	○				112	100	112	33		4100	

Measurement of flow coefficients Cv according to DIN EN 60534

Flow speeds of 8 m/sec should not be exceeded

Medium Water
both sides self sealing

1 bar = 14,5 PSI

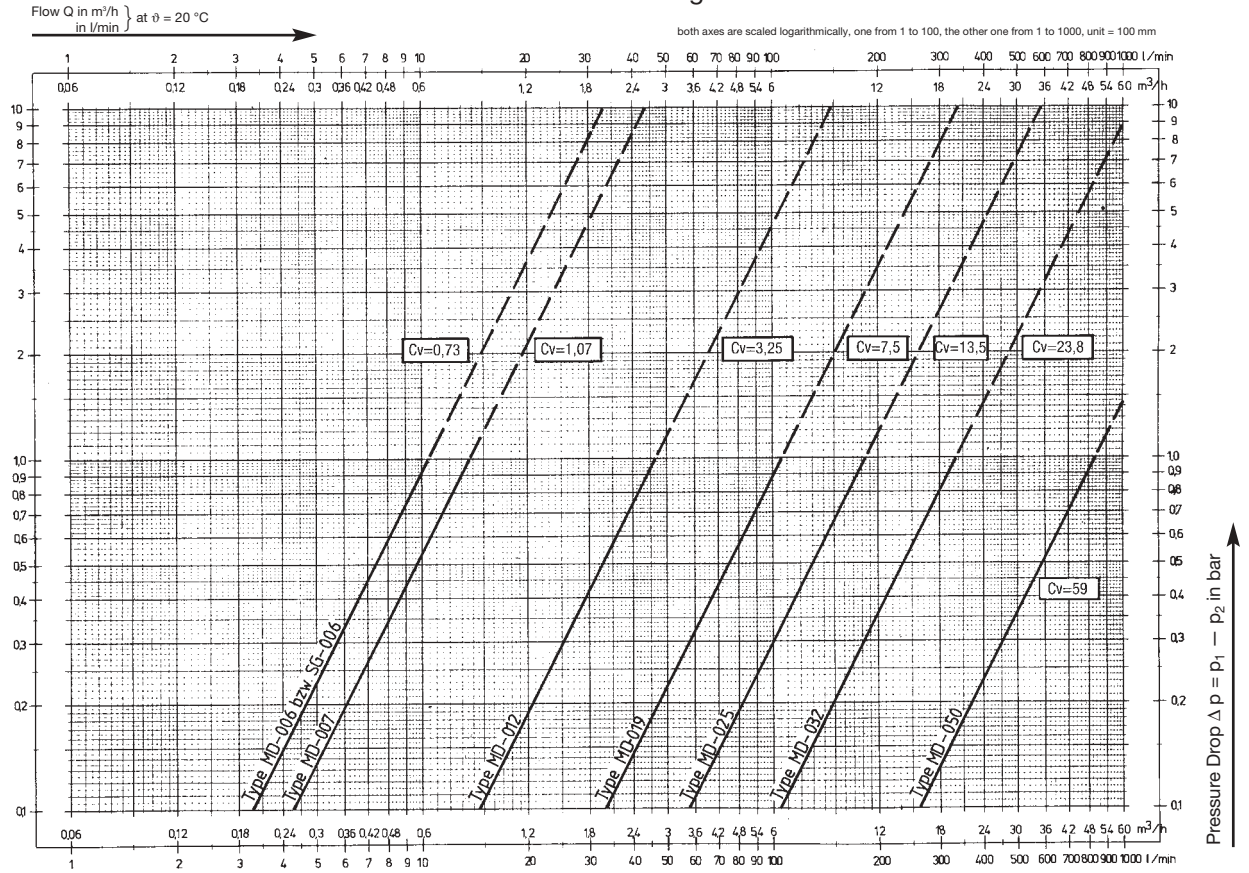

Medium Air working pressure 6 bar gauge pressure
both sides self sealing

