

General short instruction information

Multi coupling in plate construction for customer-side provision

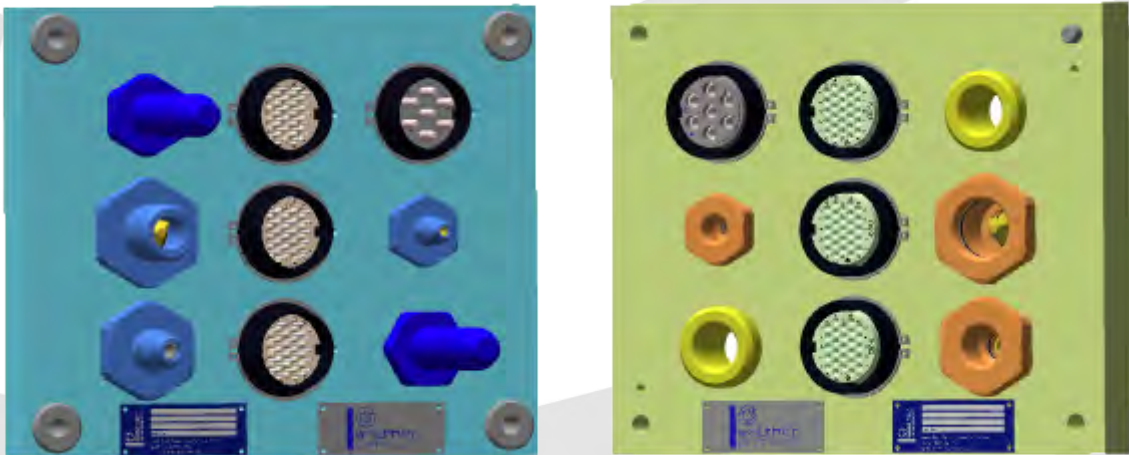

Revision: F

Date: 26.04.2018 • Creator: nh • Approved by: Norbert Heinz
These operating instructions are not subject to the change service.
german ident no 149172
english ident no 149173





Table of contents

1	afety instructions	4
1.1	Explain the dangerous- and warning hints	4
1.2	For your safety	4
1.2.1	General information regarding safety precautions	4
1.2.2	Safety precautions	5
1.2.3	Distribution of existing instructions	5
1.2.4	Incorrect selection, improper handling	5
1.2.5	Responsibility of the user	6
1.2.6	Load specifications, torques, framework conditions	6
1.2.7	Other questions	6
1.3	Instructions for the selection of a quick coupling system	7
1.3.1	Specifications and standards	7
1.3.2	Construction size	7
1.3.3	Compatibility of media	7
1.3.4	Media with low inflammability	7
1.3.5	Environment	8
1.3.6	Mechanical loads	8
1.3.7	Pressure	8
1.3.8	Vacuum	9
1.3.9	Coupling or decoupling under pressure	9
1.3.10	Temperature	9
1.3.11	Radiation heat	10
1.4	Correct Installation	10
1.4.1	Examination prior to installation	10
1.4.2	Quick coupling systems or (replacement) parts from other manufacturers	10
1.4.3	Connecting quick couplings systems	10
1.4.4	Heating (e.g. welding and soldering)	11
1.4.5	Connecting electrical components	11
1.4.6	Installation location	11
1.4.7	Protective caps and connectors	11
1.5	Maintenance instructions	12
1.5.1	Maintenance plan	12
1.5.2	Functional testing	12
1.5.3	Replacement intervals	13
2	Operating conditions	14
2.1	General	14
2.2	Lubricants	14
2.3	Pressure range	15
2.4	Electrical voltages	15
2.5	Durability and lifetime	15
2.6	Cleaning	15
2.7	Heavily magnetic fields and bearings	15
3	Product description	16
3.1	Proper use	16

3.2	Technical data	16
4	Installation instruction	17
4.1	Attachment.....	17
4.2	General.....	17
4.3	Preparing for installation	18
4.4	Initiators	18
4.5	Multi-coupling with an angle console	19
4.6	Floating position	19
4.7	Preparation of the fluidic connections	20
4.8	Preparation of the electric connections	20
4.9	Preparation and crimping of the lines.....	21
4.10	Assembly and disassembly of the electric plug inserts	26
4.10.1	<i>Electric plug inserts with a rubber support.....</i>	<i>26</i>
4.10.2	<i>Electric plug inserts with a plastic support</i>	<i>30</i>
4.10.3	<i>Quick-changing heads</i>	<i>32</i>
4.10.4	<i>Modularly structured electric plug inserts</i>	<i>33</i>
4.11	Assembly and disassembly of single conductors (ET250 / 350)	37
5	Maintenance and Repair	39
5.1	Maintenance.....	40
5.1.1	<i>Maintenance of electrical plug inserts</i>	<i>41</i>
5.2	Repairs	41
6	Operating	42
6.1	Coupling procedure.....	42
6.2	Decoupling procedure	42
7	Contact data	43



1 safety instructions

1.1 Explain the dangerous- and warning hints

	<p>⚠ DANGER</p> <p>Indicates a danger with high risk. If a warning is not observed, serious injuries or death are the direct consequence.</p>
	<p>⚠ WARNING</p> <p>Indicates a danger with medium risk. If a warning is not observed, serious injuries or death are possible.</p>
	<p>⚠ CAUTION</p> <p>Indicates a danger with low risk. If a warning is not observed, minor to medium severity injuries are possible.</p>
	<p>⚠ ATTENTION</p> <p>Risk or unsafe handling which may cause considerable property or financial damages.</p>
	<p>NOTE</p> <p>Shows information which is concerned either directly or indirectly with the safety of personnel or the protection of the system. If the notification is not observed, faults or property damages are possible.</p>

1.2 For your safety

1.2.1 General information regarding safety precautions

	<p>⚠ ATTENTION</p> <p>This lists instructions for the selection and handling of WALTHER-PRÄZISION quick coupling systems and accessories. These instructions must be applied in conjunction with all other information issued by WALTHER-PRÄZISION pertaining to the relevant products and their accessories. The following instructions must be read and observed prior to the selection and use of a WALTHER-PRÄZISION quick coupling system or the appropriate accessories.</p>
	<p>NOTE</p> <p>WALTHER-PRÄZISION grants a warranty for maintenance/repairs carried out by WALTHER-PRÄZISION or by personnel trained by WALTHER-PRÄZISION. If this work is carried out by a third-party, WALTHER-PRÄZISION accepts no liability for (subsequent) damages.</p>

1.2.2 Safety precautions

	⚠ WARNING
	<p>Quick coupling systems may fail unpredictably for many reasons.</p> <p>Personal injury and/or property damages.</p> <ul style="list-style-type: none">▶ For this reason, design all systems and plants in such a way that a failure of the quick coupling system or the relevant supply line will not result in personal injury and/or property damages.

1.2.3 Distribution of existing instructions

	⚠ ATTENTION
	<p>Give a copy of all product-relevant instructions to all persons entrusted with the selection or handling of quick coupling systems. Read the safety precautions and the product-specific publications before selecting and/or using a quick coupling system.</p>

1.2.4 Incorrect selection, improper handling

	⚠ DANGER
	<p>Incorrect selection or improper handling of quick coupling systems and accessories.</p> <p>The consequences are property damage, injuries or death. The following points must be prevented:</p> <ul style="list-style-type: none">▶ Uncontrolled flying of the quick coupling systems or other components with high potential risk.▶ Trapping of body parts caused by reaching between the coupling sides.▶ Application of electrical voltage in decoupled state.▶ Leaking of media under high pressure and at high speed.▶ Impacting, dropping or falling of components caused by a failure of the power unit.▶ Dangerous lashing out of the connection hose (whip effect).▶ Explosion or taking fire of the employed media.▶ Body contact with dangerous media.▶ Leaking of media that is used in chemical processes.▶ Technical specifications are not maintained.

1.2.5 Responsibility of the user

	⚠ ATTENTION
	<p>Return of quick coupling systems that are contaminated with a type of media that is a risk to health.</p> <p>Media that is a risk to health is released during the removal process.</p> <ul style="list-style-type: none"> ▶ The quick coupling system must be completely clean when returning it to WALTHER-PRÄZISION. The sender (client) is responsible for ensuring this.

	NOTE
	<p>Due to the different functionalities and the versatility of use of quick coupling systems, WALTHER-PRÄZISION and the associated network of dealers is not able to guarantee that a specific quick coupling system is suitable for each specific end use. These brief instructions do not analyse all of the technical details that are to be taken into consideration in the selection of the quick coupling system. The user is responsible for their own analysis of the following points.</p> <ul style="list-style-type: none"> ▶ For the safe operation and observation of the maintenance and servicing. ▶ The selection of their quick coupling system. ▶ The fulfilment of the requirements of the end user. ▶ The safety precautions which are necessary in order to avoid personal injuries and damage when using quick coupling systems. ▶ Own technical changes.

1.2.6 Load specifications, torques, framework conditions

	⚠ ATTENTION
	<p>Not observed load specifications, torques and other framework conditions.</p> <p>Failure of the quick coupling system.</p> <ul style="list-style-type: none"> ▶ The load specifications, torques and other framework conditions specified by WALTHER-PRÄZISION must be maintained.

	NOTE
	<p>Inquire at WALTHER-PRÄZISION for these load specifications, torques and other framework conditions prior to installation.</p>

1.2.7 Other questions

If you have questions or would like further information, please consult either your supplier or WALTHER-PRÄZISION directly.

1.3 Instructions for the selection of a quick coupling system

1.3.1 Specifications and standards

	NOTE
	When selecting a quick coupling system, country-specific directives, industrial standards and the specifications of WALTHER-PRÄZISION must be taken into account and observed.

1.3.2 Construction size

	⚠ ATTENTION
	Power transfer for incompressible media. Pressure losses and warming or changes in viscosity of the transported media. ▶ The power transfer for incompressible media varies according to pressure and flow rates. The construction size of the quick coupling system and other system components must be designed in such a way that pressure losses and warming or changes in viscosity of the transported media are kept as low as possible.

1.3.3 Compatibility of media

	⚠ ATTENTION
	Compatibility between the media and the materials of the quick coupling system. Corrosion, leaks and failure of the quick coupling system ▶ Ensure the compatibility between the materials of the components of the quick coupling system and the media used.

	NOTE
	More information regarding compatibility can be found in the seal and material table in your technical catalogue from WALTHER-PRÄZISION.

1.3.4 Media with low inflammability

	NOTE
	Some types of media with low inflammability require a different seal material compared to the material used as standard.

1.3.5 Environment

	⚠ ATTENTION
	<p>Environmental conditions such as UV or radioactive radiation, ozone, mould, water, salt water, air humidity, temperature, chemicals or air contamination.</p> <p>Early wear or failures.</p> <ul style="list-style-type: none"> ▶ Attention should be paid to ensure that the relevant quick coupling system can be stored/used in the relevant environment.

1.3.6 Mechanical loads

	⚠ WARNING
	<p>Unintentional opening or movement of the locking mechanism caused by external forces acting upon it. External forces may include: Pulling the hose over an obstacle, locking mechanism with coarse contours that can be easily moved, or vibrations.</p> <p>Personal injuries caused by failure of the quick coupling system.</p> <ul style="list-style-type: none"> ▶ Quick coupling systems should, for this reason, only be used in the above conditions if a safety lock is present and usage testing has been carried out.

	⚠ ATTENTION
	<p>Unintentional opening or movement of the locking mechanism caused by external forces acting upon it. External forces may include: Pulling the hose over an obstacle, locking mechanism with coarse contours that can be easily moved, or vibrations.</p> <p>Property damages caused by failure of the quick coupling system.</p> <ul style="list-style-type: none"> ▶ Quick coupling systems should, for this reason, only be used in the above conditions if a safety lock is present and usage testing has been carried out.

1.3.7 Pressure

	⚠ DANGER
	<p>The maximum operating pressure of the quick coupling system is exceeded.</p> <p>The consequences are serious injuries or death.</p> <ul style="list-style-type: none"> ▶ The correct selection of the quick coupling system in accordance with the existing operating pressure of the plant.

	⚠ ATTENTION
	<p>The maximum operating pressure of the quick coupling system is exceeded.</p> <p>The consequences are property damages.</p> <ul style="list-style-type: none"> ▶ The correct selection of the quick coupling system in accordance with the existing operating pressure of the plant.

	NOTE
	Do not confuse bursting pressure with operating pressure.

1.3.8 Vacuum

	NOTE
	Not all quick coupling systems can be used for vacuum applications. Quick coupling systems for vacuum applications must be selected in such a way that they do justice to the special operating conditions and pressures.



1.3.9 Coupling or decoupling under pressure

	NOTE
	Decoupling under pressure: Quick coupling systems must in principle be pressure-free when decoupling/decoupled. Unless otherwise indicated, this pressure-free state must be maintained until the system is next coupled.

	⚠ ATTENTION
	The application requires coupling and decoupling under pressure. No proper functionality of the quick coupling system. ▶ Only use quick coupling systems that enable coupling and decoupling under pressure.

	NOTE
	The maximum coupling pressure may be lower than the maximum operating pressure.

1.3.10 Temperature

 	⚠ WARNING
	Exceeding or undercutting the permitted temperature values at a standstill or in active operation. Burning or freezing. ▶ For brief handling procedures, use protective gloves. ▶ For longer-lasting contact, observe the appropriate current safety regulations.

1.3.11 Radiation heat

	⚠ WARNING
	<p>Radiation heat acting on quick coupling systems may ruin the sealing material or even the body of the coupling.</p> <p>Personal injury</p> <p>▶ This risk must be taken into account by the user and suitable measures must be taken.</p>

	⚠ ATTENTION
	<p>Radiation heat acting on quick coupling systems may ruin the sealing material or even the body of the coupling.</p> <p>Property damage</p> <p>▶ This risk must be taken into account by the user and suitable measures must be taken.</p>

1.4 Correct Installation

1.4.1 Examination prior to installation

	NOTE
	<p>Prior to installing the quick coupling system, you must check whether the material of the components, the seal material and the reference data match the specifications. Prior to final installation, both sides of the coupling should be coupled and decoupled as a test.</p>

1.4.2 Quick coupling systems or (replacement) parts from other manufacturers

	NOTE
	<p>Use only WALTHER-PRÄZISION original (replacement) parts in order to ensure the operation and maintenance of your quick coupling system. We expressly remind you that we do not offer liability, warranty and service, when (replacement) parts from other manufacturers are used or when combinations are employed which use (replacement) parts from other manufacturers.</p>

1.4.3 Connecting quick couplings systems



	NOTE
	<p>When connecting quick coupling systems, use an appropriate sealant between the cylindrical threads or conical sealing threads. Make sure that the sealant is compatible with the material to be conveyed. Use the provided spanner flats during installation. Always use the correctly sized wrench. Never use pipe tongs or a variable wrench since this will ruin the thread/sealing surfaces in the quick coupling systems and other components of the quick coupling system. Too great a tightening torque may ruin the threads of the quick coupling systems or burst the thread block.</p>

1.4.4 Heating (e.g. welding and soldering)

	⚠ WARNING
	<p>When heating coated components, dangerous gases may be generated which may, among other things, damages seals.</p> <p>Personal injury</p> <ul style="list-style-type: none"> ▶ Use the appropriate guards and wear personal protective equipment when carrying out this task. ▶ Prevent heating of coated components.

	⚠ ATTENTION
	<p>When heating coated components, dangerous gases may be generated which may, among other things, damage seals.</p> <p>Property damage</p> <ul style="list-style-type: none"> ▶ Prevent heating of coated components.

1.4.5 Connecting electrical components

 	⚠ DANGER
	<p>Electrical voltage to components.</p> <p>Serious injuries or death may result from touching components which carry power.</p> <ul style="list-style-type: none"> ▶ Switch off the power supply. ▶ Secure the power supply to prevent it from being switched back on. ▶ Pay attention to the wiring diagram. ▶ Check that no voltage is present.

1.4.6 Installation location

	NOTE
	<p>Install the quick coupling system in such a way that the user is not at risk of slipping, falling, being sprayed, or coming into contact with hot or moving parts.</p>

1.4.7 Protective caps and connectors

	NOTE
	<p>Seal the connections on the coupling sides when they are not required in order to prevent contamination.</p>

1.5 Maintenance instructions

1.5.1 Maintenance plan

	⚠ WARNING
	<p>Failure to carry out maintenance or too large a maintenance gap.</p> <p>Personal injury</p> <p>▶ Observe the contents of the maintenance plan.</p>

	⚠ ATTENTION
	<p>Failure to carry out maintenance or too large a maintenance gap.</p> <p>Property damage</p> <p>▶ Observe the contents of the maintenance plan.</p>

	NOTE
	<p>A maintenance plan must be created and executed by the user. This maintenance plan should contain, at least, the following points, which are to be taken into account and examined in a visual inspection of the quick coupling system.</p> <ul style="list-style-type: none"> ▶ Check for damaged or corroded components of all types. ▶ Leaks from the connection, valve or other components. ▶ Broken coupling mounts (especially for breakaway quick closing devices). ▶ These points require the immediate replacement or repair of the quick coupling system.

	NOTE
	<p>A maintenance plan must be created and executed by the user. This maintenance plan should contain, at least, the following points which are to be taken into account in a visual inspection of the plant.</p> <ul style="list-style-type: none"> ▶ Contamination of the exterior or the connection zone of the quick coupling system. ▶ Other mounts. ▶ Protective mechanisms. ▶ Fluid level, fluid characteristics and ventilation of the system. ▶ Tension relief ▶ Bending radii.

1.5.2 Functional testing

	NOTE
	<p>Please put the system under working pressure. Check the quick coupling system for potential faults and leaks. Check the switches and initiators of safety mechanisms.</p>

	NOTE
	After functional testing, carry out a test phase prior to actual operation. The operating personnel should be protected by the appropriate personal protective equipment as they work on the test phase.

1.5.3 Replacement intervals

	NOTE
	The special replacement intervals must be adapted to correspond to values related to experience, country-specific directives and industrial standards. They also depend on operating safety, standstill times and failure risks.

2 Operating conditions

2.1 General

- The permitted operating temperature lies between +5 °C and +70 °C, deviating operating temperatures are generally to be coordinated with WALTHER-PRÄZISION.
- The permitted storage temperature lies between +10 °C and +35 °C, deviating storage temperatures are generally to be coordinated with WALTHER-PRÄZISION.
- The maximum relative air humidity during operation may not exceed 75 %.
- The maximum relative air humidity during storage may not exceed 60 %.
- The appropriate de-rating diagrams must be taken into account for the transfer valves of electrical plugs.
- The components of WALTHER-PRÄZISION may not be exposed to UV radiation or radioactive radiation during operation or storage (e.g. no components may be stored outdoors), unless this has been expressly agreed.
- The quick coupling system may not freeze or be exposed to dew during operation or storage.
- In order to ensure correct functionality, the components are to be stored in an environment that is free from dust. They are also to be protected from vibrations.
- Only original WALTHER-PRÄZISION parts may be used. These must be installed correctly.

In order to ensure perfect functionality, after a storage period of at the latest 24 months, the components must be maintained by WALTHER-PRÄZISION for the purpose of monitoring and repairs.

2.2 Lubricants

- WALTHER-PRÄZISION uses Arcanol Multi 3[®] for the greasing of connecting surfaces, if the conditions of use permit it. WALTHER-PRÄZISION offers Arcanol Multi 3[®] in 1kg units.
- At WALTHER-PRÄZISION electrical contacts are sprayed with Kontasynth BA. This is also offered by WALTHER-PRÄZISION. When spraying, ensure that the spraying zone is limited to the contact surfaces.
- WALTHER-PRÄZISION fibre-optic cables are not greased.

In addition, when greasing, the following points must be observed:

- When using Arcanol Multi 3[®] and Kontasynth BA attention should be paid to ensure compatibility with the seal quality and the material.
- Water/grease combinations or air/grease combinations in which the properties Arcanol Multi 3[®] and/or Kontasynth BA are modified (e.g. resinification) are not permitted.
- For deviating media/grease combinations, please consult WALTHER-PRÄZISION.

2.3 Pressure range

- The maximum operating pressure may not be exceeded whilst taking into account the connections.
- The minimum test factor is 1.3 times the operating pressure, in special sectors, it may be 1.5 or 1.67 times the operating pressure.

2.4 Electrical voltages

- The control voltage must be 24 V DC with a tolerance of –15 % to +10 %.
- The EMC directive 2014/30/EU dated 26.02.2014 must be maintained.

2.5 Durability and lifetime

The durability and lifetime of the quick coupling system depend on the following:

- Environmental conditions
- Conditions of use and
- construction features of the on-site (client-side) situation

2.6 Cleaning

Clean your quick coupling system once a week or every 10,000 coupling cycles. To do this, use the usual cleaning agents such as dry ice or turpentine. After doing so, lubrication must be carried out.

2.7 Heavily magnetic fields and bearings

The components meet the specifications of the EMC directive.

Only when the specifications of WALTHER-PRÄZISION with regard to set up, initial use, maintenance, repairs etc. are maintained, will WALTHER-PRÄZISION accept liability and warranty for the quick coupling system.

3 Product description

The quick coupling system is made up of:

Fixed side

Removable side

- When decoupled, both sides of the quick coupling system must be protected against external contamination.
- The quick coupling system may only be used in accordance with the intended purpose.
- The technical specifications must be adhered to.
- WALTHER-PRÄZISION is not responsible for any personal injuries or property damages caused as a result of incorrect use and of ignoring the technical specifications.

3.1 Proper use

- The quick coupling system is used to connect components that carry media.
- The coupling and decoupling procedures are triggered by an on-site customer control.
- With few exceptions, coupling and decoupling must be carried out without pressure and without voltage.
Any exceptions must be coordinated with WALTHER-PRÄZISION.
- The elements in the free half may not be in fixed casings.
- Any radial loads that occur as a result of long and heavy connecting hoses are to be cushioned by appropriate support equipment.
- Maintenance of technical data.

3.2 Technical data

Technical data and specifications can be obtained from the specific operating instructions for the relevant multiple coupling.

Due to the different functionalities and the versatility of use of quick coupling systems, WALTHER-PRÄZISION and their associated network of dealers is not able to guarantee that a specific quick coupling system is suitable for each specific end use.

4 Installation instruction

4.1 Attachment

Our technical service team (contact details on the final page) are available to answer any questions you may have on creating attachment points for your multi-coupling or general queries on installation, commissioning or maintenance.

Please ask our technical service team if you need any assembly drawings.

4.2 General



The quick coupling systems are to be installed under the observation of the general accident prevention regulation in such a way that

- trouble-free operation is ensured in conjunction with the product description.
- external damage to the built-in elements and all moving parts is excluded.

In order to prevent damages to the quick coupling system or life-threatening injuries to people during the fitting of the quick coupling to the machine, the following points must be observed.

- The installation (assembly and installation) of the quick coupling system may only be carried out by persons qualified for this task under the observation of the safety precautions.
- Prior to the start of installation, the quick coupling system is to be checked for transportation damages.
- All connections of the quick coupling system (cables, hoses and pipelines) are to be laid in such a way that no trip hazards are created (stumbling, falls).
- Prior to installation of the quick coupling system or the initial use of the system, the pipeline network must be cleaned. The media elements are to be removed, if required, in order to prevent damage to the seals during cleaning.

The following special risks are to be expected during the installation of the quick coupling system:

	<p>⚠ WARNING</p> <p>Falling, tipping and throwing of objects.</p> <p>Personal injuries are possible.</p> <ul style="list-style-type: none"> ▶ Secure quick coupling systems and parts thereof properly. ▶ Work in the safe zone. ▶ Check screw connections for firm seating.
	<p>⚠ WARNING</p> <p>Sharp-edged parts that are freely accessible.</p> <p>Risk of cuts</p> <ul style="list-style-type: none"> ▶ Wear protective gloves.
	<p>NOTE</p> <p>Use only WALTHER-PRÄZISION original (replacement) parts in order to ensure the operation and maintenance of your quick coupling system. We expressly remind you that we do not offer liability, warranty and service, when (replacement) parts from other manufacturers are used or when combinations are employed which use (replacement) parts from other manufacturers.</p>

4.3 Preparing for installation

Before removing the quick coupling system from the packaging, check the assignment of free half to fixed half.

The following information is included on the packaging produced by WALTHER-PRÄZISION:

- Drawing number
- ID number

When assigning fixed and removable sides, make sure that the two halves match.

	NOTE
In the case of loosely supplied parts the WALTHER-PRÄZISION “Application Technology and Service” should be consulted immediately (see “Contact details”).	

4.4 Initiators

After the installation of free and fixed halves, all initiators must be set. The contact signal for the initiator is a firm stop (9). The stop may not be undone or adjusted.

The two counternuts (11) are used to adjust the initiator to the appropriate stop. The perfect functionality of the initiators (10) must be ensured.

The switching distance of the relevant installed initiators is to be obtained from WALTHER-PRÄZISION.

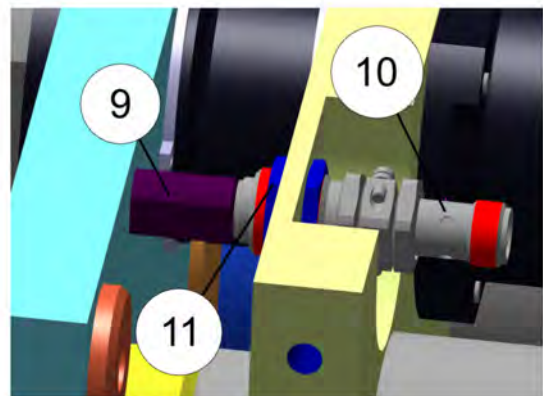

4.5 Multi-coupling with an angle console

Important!

The surface of the client structure onto which the angle console is to be secured must always be a little lower than specified in the drawings by Walther-Präzision.

Reason!



The angle console can only be raised slightly, but can never be lowered since then the surface of the client structure would need to be ground.

The angle console is raised using shims that are slipped under the angle console near the fixture screws.

The raising, and thus alignment, of the angle console must be carried out using the installed levelling sleeves (see section "Floating position").

4.6 Floating position

The floating position is implemented differently for all multicouplings, including alternating from free to fixed half.

	<p>⚠ ATTENTION</p>
	<p>When installing the multicouplings, the multicoupling plates must have a floating position.</p> <p>The functionality of the quick coupling system is not given.</p> <ul style="list-style-type: none"> ▶ When installing, at least 2 diagonal spacer bushes must be replaced by levelling bushes.
	<p>⚠ ATTENTION</p>
	<p>There is no floating position available in operation.</p> <p>The functionality of the quick coupling system is not given.</p> <ul style="list-style-type: none"> ▶ Prior to the initial commission, all levelling bushes must again be replaced by the previously exchanged spacer bushes.

This only applies if the floating bearing is included in the design.

4.7 Preparation of the fluidic connections

Establishing the link between the connections of the fluid subassembly elements and the connections of the client-side components.

	⚠ ATTENTION
	<p>Not observed load specifications, torques and other framework conditions.</p> <p>Failure of the quick coupling system.</p> <ul style="list-style-type: none"> ▶ The load specifications, torques and other framework conditions specified by WALTHER-PRÄZISION must be maintained.

	NOTE
	<p>Inquire at WALTHER-PRÄZISION for these load specifications, torques and other framework conditions prior to installation.</p>

4.8 Preparation of the electric connections

	NOTE
	<p>The electrical connections may only be established by trained and authorised electrical specialists.</p>

	NOTE
	<p>The assembly, installation, operation and maintenance of electrical plugs and contacts must be implemented in accordance with current standards for the various applications (voltage, current).</p>

	NOTE
	<p>The crimping of the individual electrical contacts may only be carried out with suitable tools. Suitable installation/removal tools are required for the installation of electrical plugs in the electrical plug insert.</p>

This tools can be purchased from WALTHER-PRÄZISION.

4.9 Preparation and crimping of the lines

This preparation work must be carried out for all electrical plug inserts.

**Crimping tool 0.14 mm² - 4 mm² ID No. 23348
7-022-50150**



**Crimping tool 6 mm² - 35 mm² ID No. 103529
7-022-50190**



Crimping is to be carried out in accordance with DIN EN 60352 and is to be implemented by trained personnel.

	⚠ ATTENTION
	The individual wires may not be able to be pulled out or broken off after crimping.

Strip the cable completely to dimension X.
Dimension X depends on construction size (see Table).

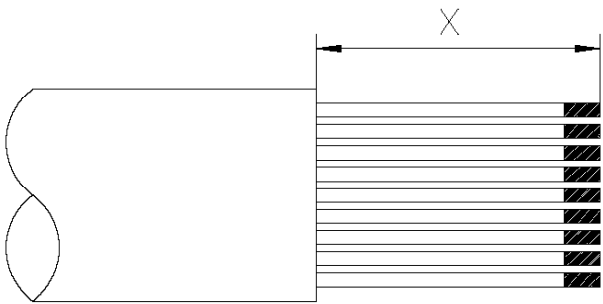
	Construction size	Dimension X (guideline value)
	I	40 mm
	II	40 mm
	III	50 mm

Then strip the individual wires with a suitable tool.

The pictures below show examples of correct and incorrect crimping.

The stripping must be carried out in such a way that the individual wire is visible when fitting and crimping the pins and sockets. The sleeve may not be stripped too far.

Correctly crimped.



Not correctly crimped.

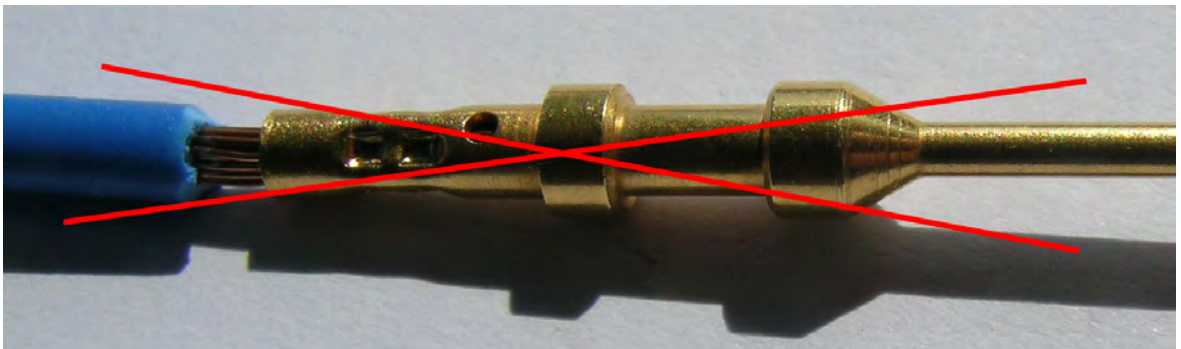

Hexagonal crimping

Correctly crimped.



Not correctly crimped.
Pay attention to the correct size of the crimping tool.

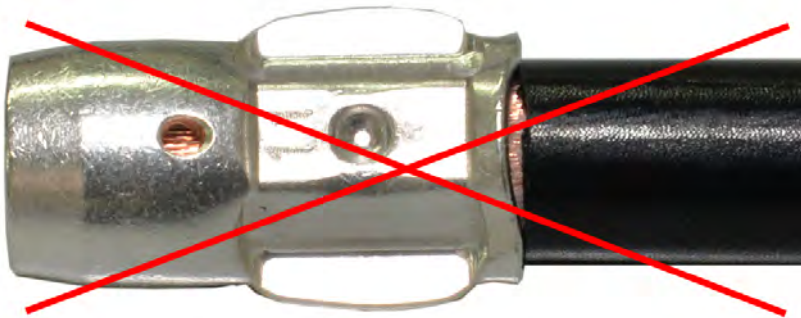

Correctly crimped.

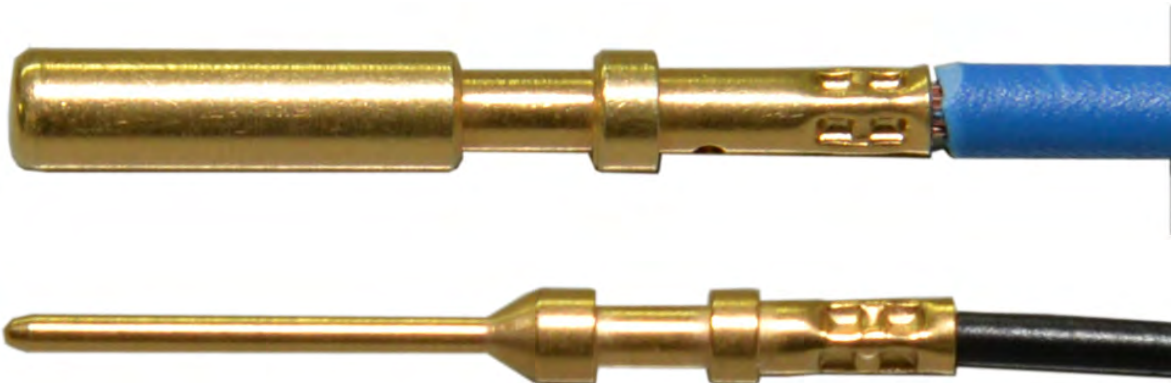

Not correctly crimped.

Do not press the crimp ovally. The crimp point may burst or will not fit into the insert.



Do not bend or flatten the crimping. The crimp point may break or will not fit into the insert.

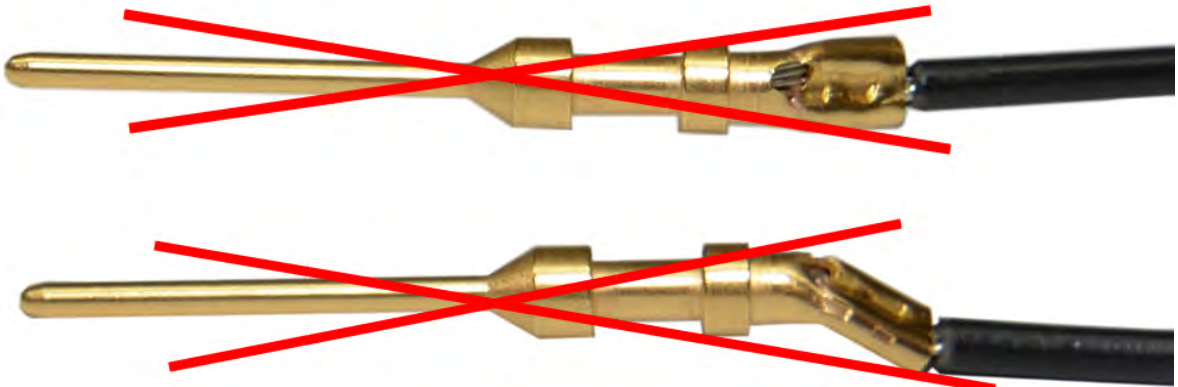

Example for a correct 4 mm² crimping.



4.10 Assembly and disassembly of the electric plug inserts

WALTHER-PRÄZISION markets a variety of electrical plug inserts such as:

- Electrical plug inserts with a rubber mount.
- Electrical plug inserts with a plastic mount.
- Quick change heads.
- Modularly constructed electrical plug inserts.

The installation and maintenance of the various electrical plug inserts is described below.

4.10.1 Electric plug inserts with a rubber support

4.10.1.1 Inserting the individual wire into the rubber mount

There are a variety of installation tools available for purchase from WALTHER-PRÄZISION suitable for use with different cross-sections.

	Order number WALTHER-PRÄZISION	ID No.	Contact diameter [mm]
Installation tool pin/socket	7-022-50131	21491	1, 1.2
Installation tool pin/socket	7-022-50079	12928	1.5, 2, 2.5
Installation tool pin/socket	7-022-50090	12936	3, 4
Installation tool pin/socket	7-022-50097	12939	5
Installation tool pin/socket	7-022-50100	12943	6
Installation tool pin/socket	7-022-50154	61783	8, 11



The individual wire is, as shown in the picture, placed in the half-shell of the installation tool and pushed from the cable side, as far as it will go, into the correct hole of the rubber mount (pay attention to plan).

The procedure is the same for pin and socket.

If the rubber mounts are dipped in white spirit or industrial alcohol prior to inserting the contacts, the insertion force will be reduced. No grease-based media may be used.

When inserting, the insertion tool must be guided parallel to the axis.

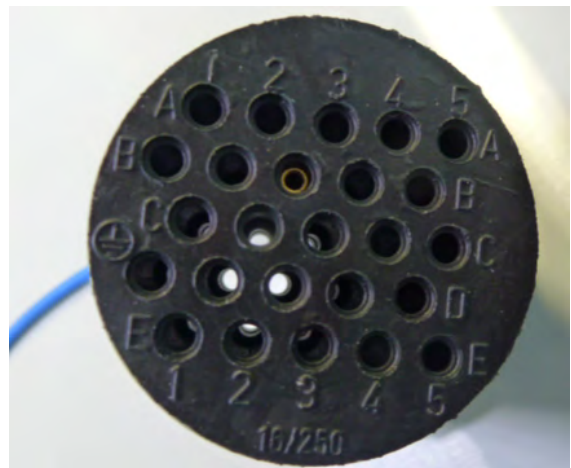
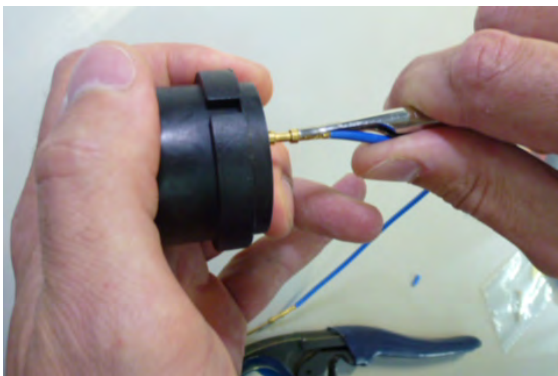
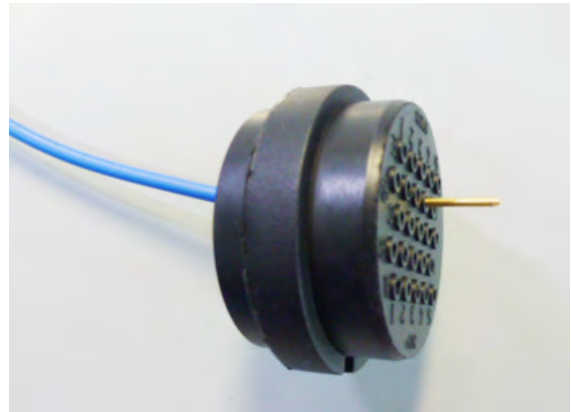
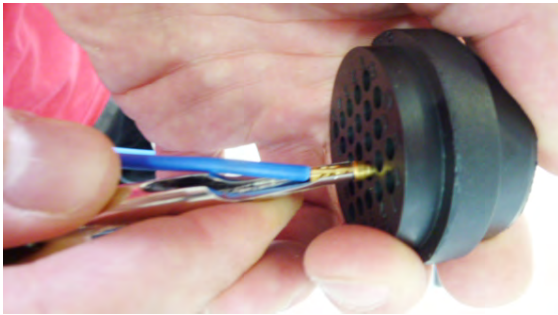

Pins and sockets that are inserted too far are to be pushed back to their engaging point with a removal tool.

4.10.1.2 Ejecting pins

With the suitable tool as determined in the table, eject the pin from the rubber mount as shown in the pictures.



	Order number WALTHER-PRÄZISION	ID No.	Contact diameter [mm]
Pin ejection tool	7-022-50133	21493	1, 1.2
Pin ejection tool	7-022-50156	84678	1.5, 1.57
Pin ejection tool	7-022-50081	12930	1.5
Pin ejection tool	7-022-50104	22436	2
Pin ejection tool	7-022-50092	12938	3
Pin ejection tool	7-022-50098	25237	5
Pin ejection tool	7-022-50102	12945	6
Pin ejection tool	7-022-50158	84679	8

4.10.1.3 Ejecting the socket

With the suitable tool as determined in the table, eject the socket from the rubber mount as shown in the pictures.



	Order number WALTHER-PRÄZISION	ID No.	Contact diameter [mm]
Socket ejection tool	7-022-50132	21492	1, 1.2
Socket ejection tool	7-022-50157	84680	1.5, 1.57
Socket ejection tool	7-022-50080	12929	1.5
Socket ejection tool	7-022-50103	22435	2
Socket ejection tool	7-022-50091	12937	3
Socket ejection tool	7-022-50099	12940	5
Socket ejection tool	7-022-50101	12944	6
Socket ejection tool	7-022-50155	61785	8

4.10.2 Electric plug inserts with a plastic support

4.10.2.1 Inserting the individual wire into the plastic mount

The individual wire is, as shown in the picture, inserted by hand from the cable side as far as it will go into the correct hole of the plastic mount until it engages (pay attention to plan).

The procedure is the same for pin and socket.

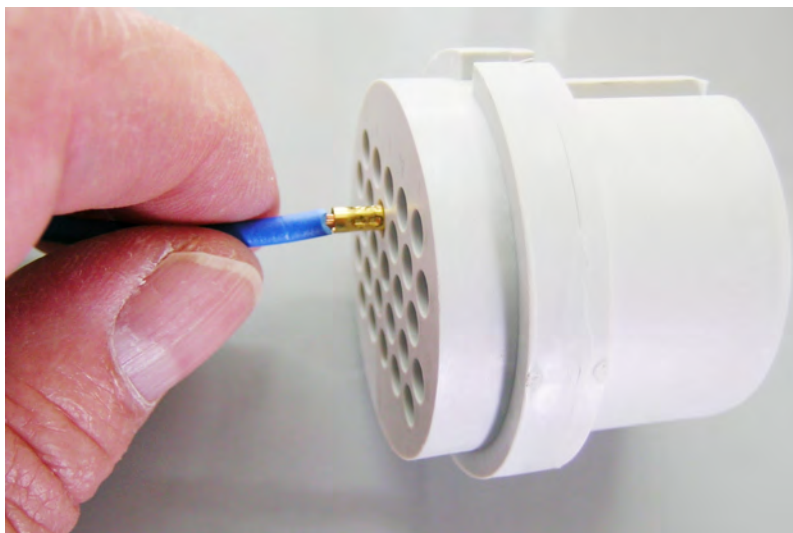

4.10.2.2 Dismantling pin and socket

There are ejector tweezers for this.



	Order number WALTHER-PRÄZISION	ID No.	Contact diameter [mm]
Ejector tweezers	7-022-50181	101500	0.5, 1, 1.5
Ejector tweezers	7-022-50201	113141	2
Ejector tweezers	7-022-50183	101491	1.5, 2.5
Ejector tweezers	7-022-50175	99526	2.5, 3
Ejector tweezers	7-022-50180	92715	4, 6
Ejector tweezers	7-022-50078	12927	10, 16

To remove the pin or the socket, as shown in the picture, place the ejector tool over the cable and push as far as it will go into the plastic mount.

Parallel to this, the individual wire is pushed slightly forwards. There may not be any tension on the cable.

In doing so, the springs of the holding ring are pushed together and the individual wire with pin or socket can be removed in the direction of the cable.

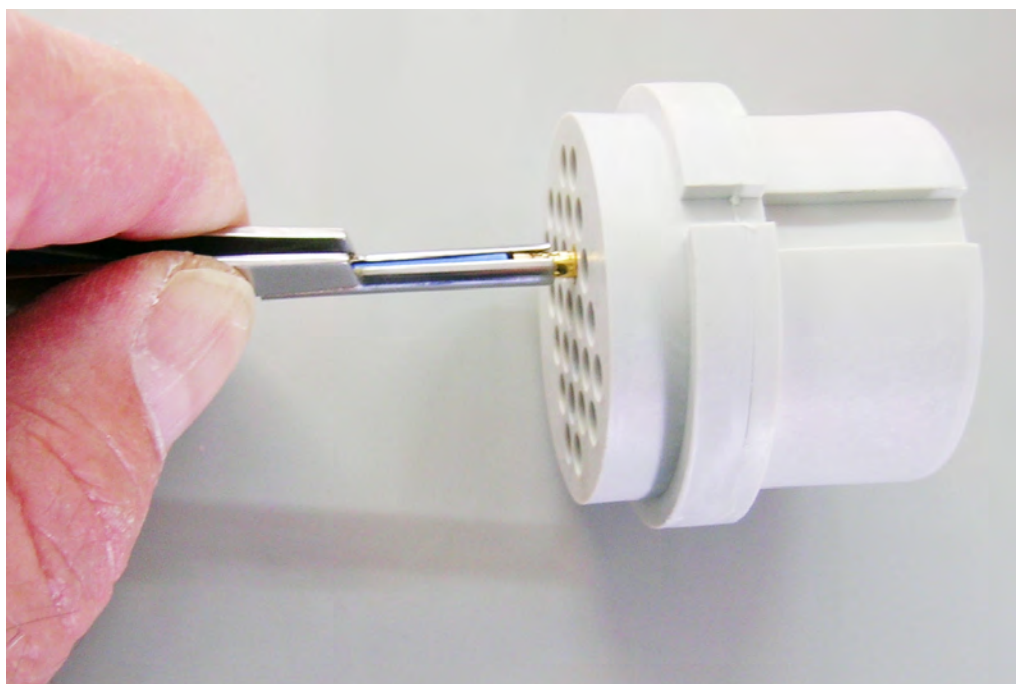

4.10.3 Quick-changing heads

Quick change heads are made up of a connection element and a docking element.

If the quick change head must be repaired due to wear, the docking element is replaced in full and the connection element remains in the housing. This enables the quick repair and restart of the quick change head without needing to separate the connections (crimped contacts) of the connection element.

4.10.3.1 Mounting and removing the connection element

The connection element is mounted and removed as described in the sections for the plastic mount.

4.10.3.2 Mounting and removing the docking element

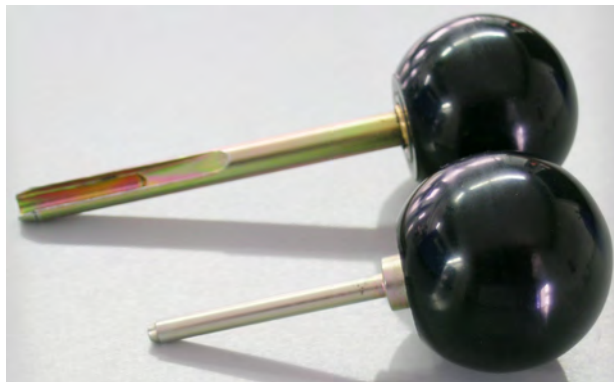

	Order number WALTHER-PRÄZISION	ID No.	Contact diameter [mm]
Insertion tool	7-022-50088	12934	1.5, 2.0
Insertion tool	7-022-50230	153035	3.0
Ejection tool	7-022-50089	12935	1.5, 2.0
Ejection tool	7-022-50231	153036	3.0

With the suitable tool as determined in the table, the contact in the relevant front section can be pushed in or out as shown in the pictures.

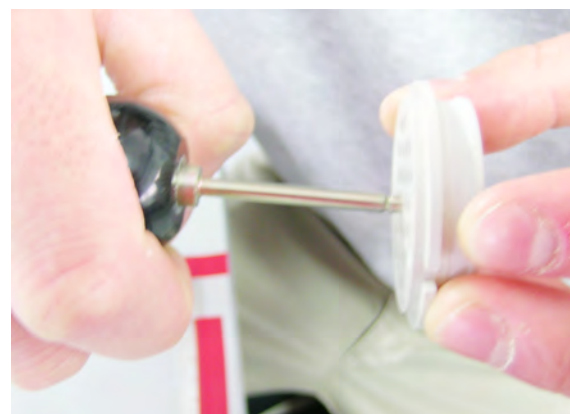

4.10.4 Modularly structured electric plug inserts

4.10.4.1 Installing the modules in the frames

The modules are placed, as shown on the pictures, in the separate frames. The two frame halves are then clipped together.

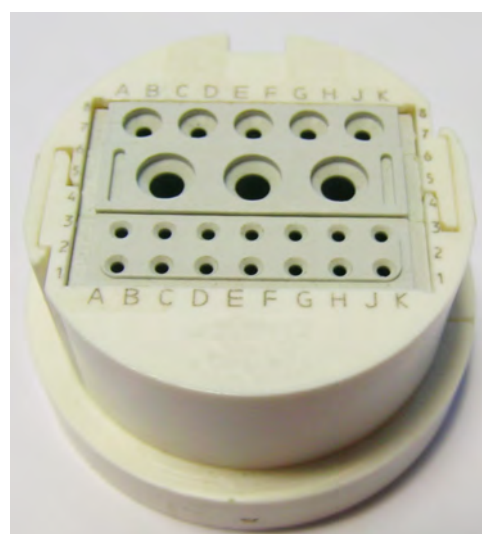
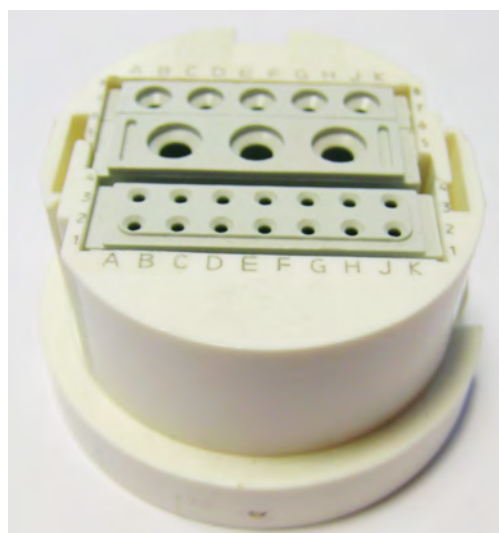
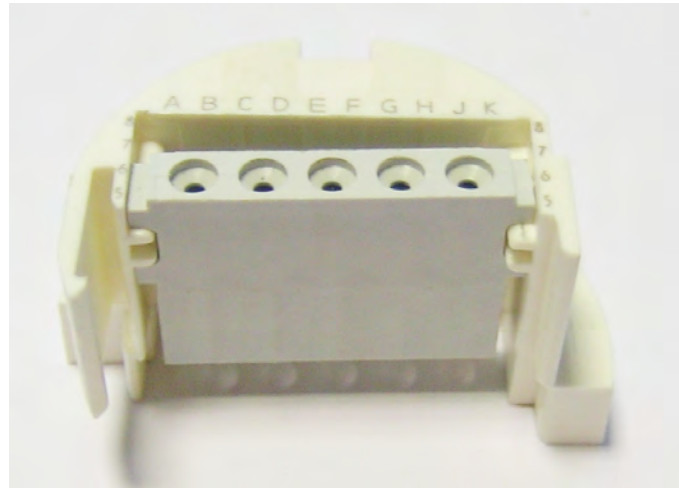

4.10.4.2 Inserting the individual wire into the plastic housing

The individual wire is, as shown in the picture, inserted by hand from the cable side as far as it will go into the correct hole of the plastic mount until it engages (pay attention to plan).

The procedure is the same for pin and socket.



4.10.4.3 Dismantling pin and socket

There are a variety of ejector tweezers for the different contact diameters.



Modular use	Order number WALTHER-PRÄZISION	ID No.	Contact diameter [mm]
Ejector tweezers	7-022-50181	101500	0.5, 1, 1.5
Ejector tweezers	7-022-50201	113141	2
Ejector tweezers	7-022-50175	99526	2.5, 3
Ejector tweezers	7-022-50183	101491	1.5, 2.5
Ejector tweezers	7-022-50180	92715	4, 6
Ejector tweezers	7-022-50078	12927	10, 16

To remove the pin or the socket, as shown in the picture, place the ejector tool over the cable and push as far as it will go into the plastic mount.
Parallel to this, the individual wire is pushed slightly forwards. There may not be any tension on the cable.

In doing so, the springs of the holding ring are pushed together and the individual wire with pin or socket can be removed in the direction of the cable.

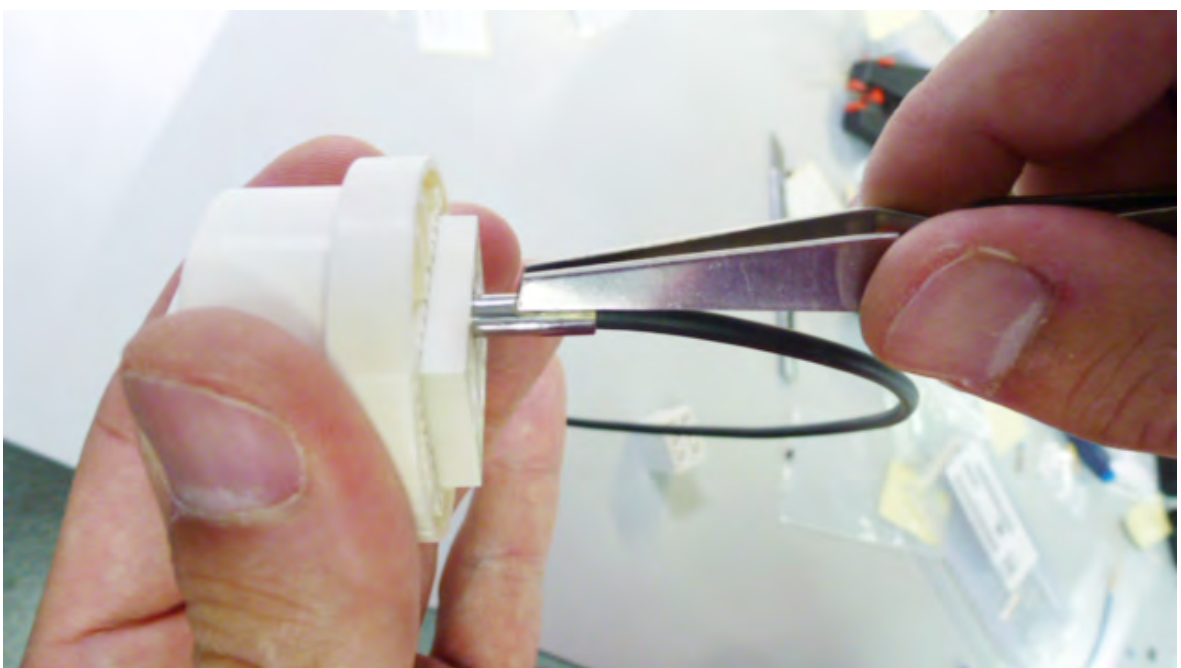
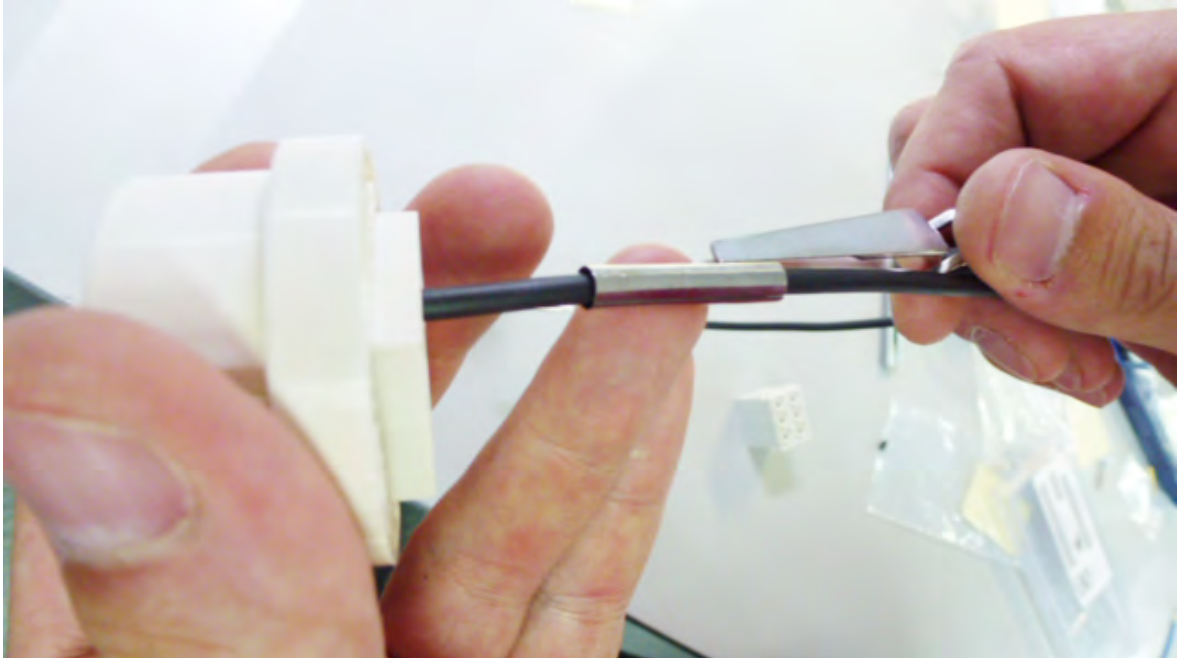

4.10.4.4 Removing the modules from the frame

The clip connection is, as shown on the pictures, bent open and separated using an appropriate tool.

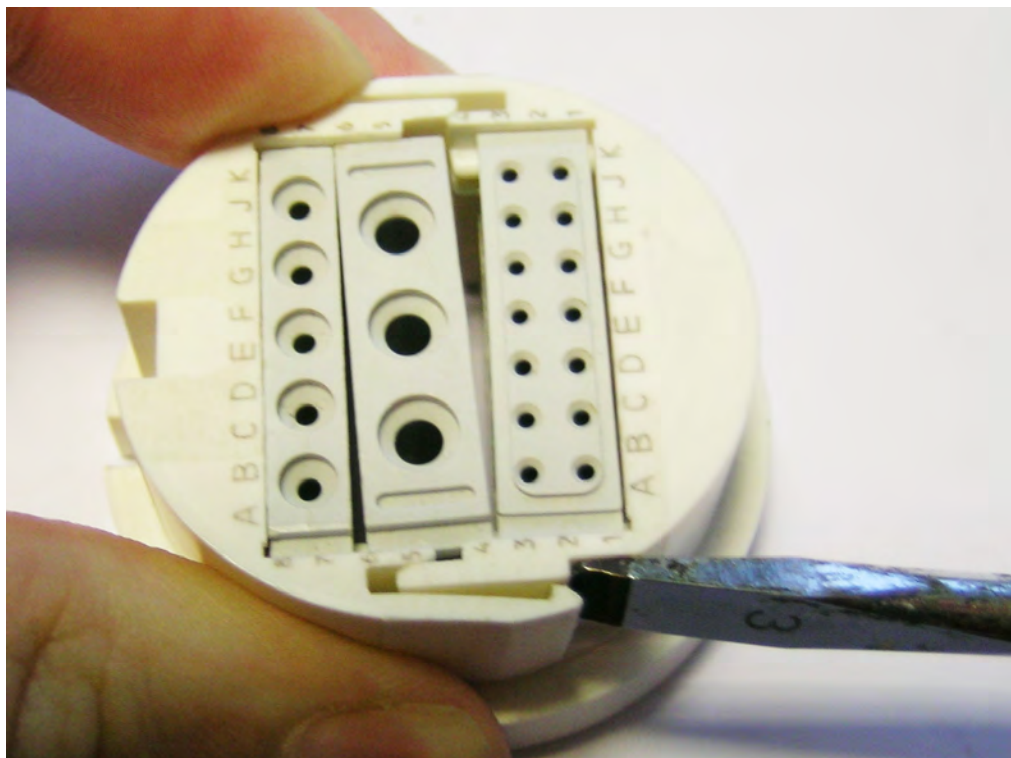
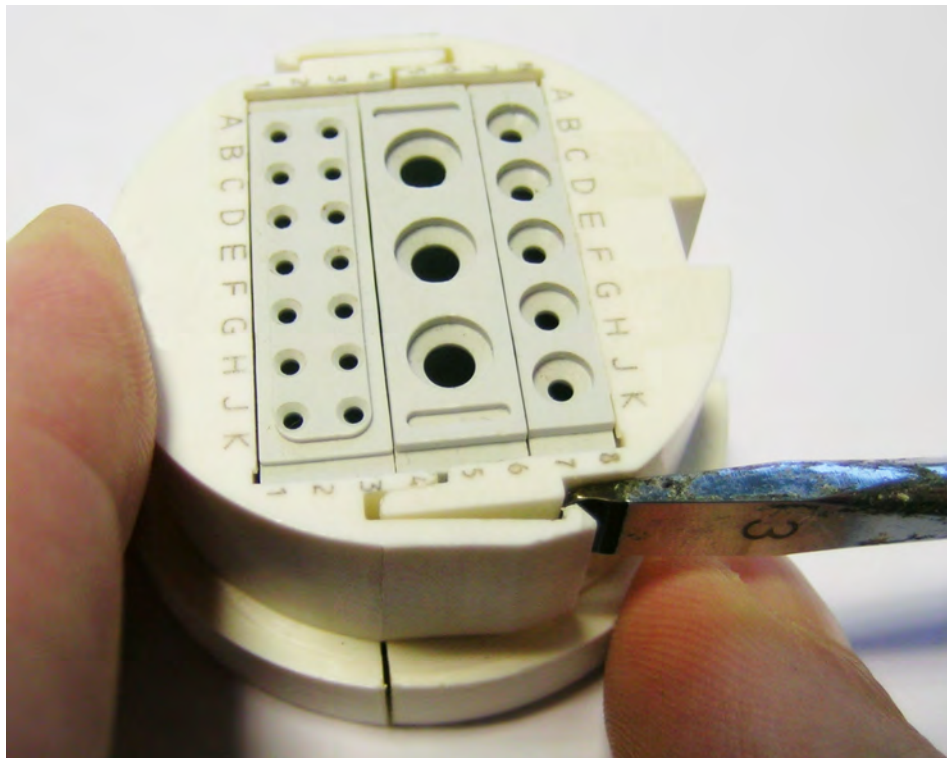

4.11 Assembly and disassembly of single conductors (ET250 / 350)

For individual wires, the same procedure for crimping applies as for every other crimped connection.

Strip the cable to the appropriate length. Strip the individual wires to the appropriate dimension. For the stripping plan, see the appropriate electrical plugs within the framework of the overall operating instructions. Crimp the individual wires and crimping sleeve with the crimping tool. The cable wires must be visible in the viewer after crimping.

Hexagonal crimping

Correctly crimped.



Not correctly crimped.
Pay attention to the correct size of the crimping tool.

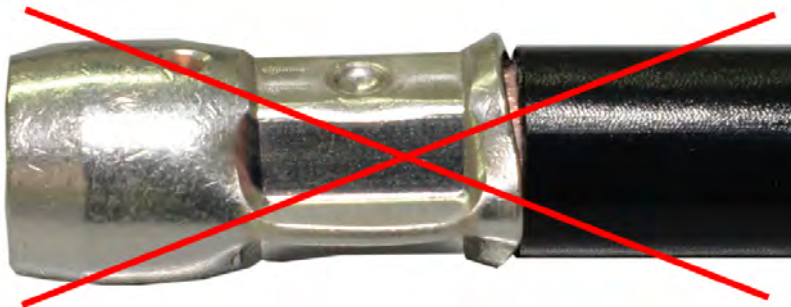
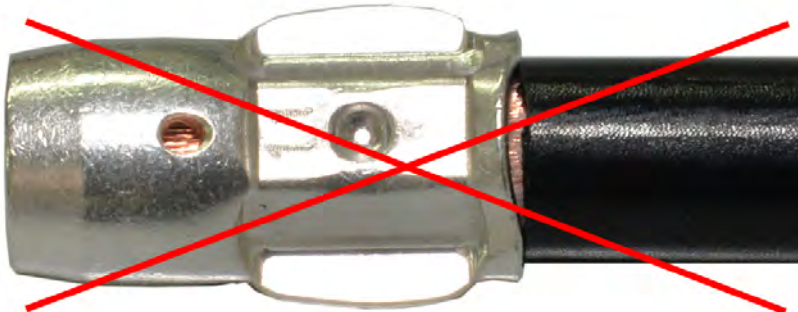

Example of individual wires

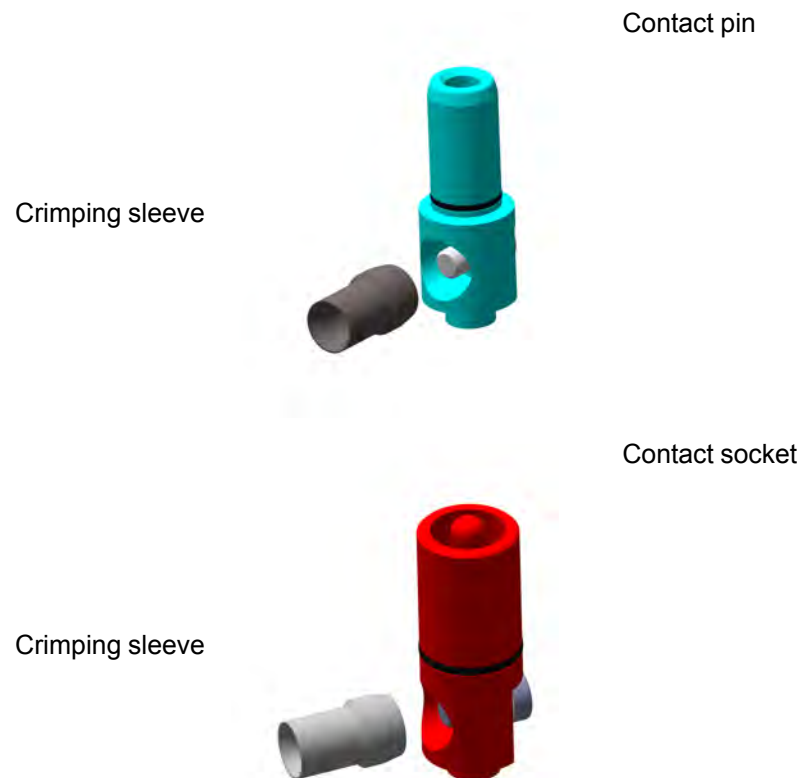



Insert the crimping sleeve into the contact pin or socket and secure using a screw.

All individual wires are described in their own special operating instructions within the framework of the overall operating instructions.

5 Maintenance and Repair

Use the quick coupling systems of WALTHER-PRÄZISION in such a way as to exclude damages.

	<p>NOTE</p> <p>WALTHER-PRÄZISION grants a warranty for maintenance/repairs carried out by WALTHER-PRÄZISION or by personnel trained by WALTHER-PRÄZISION. If this work is carried out by a third-party, WALTHER-PRÄZISION accepts no liability for (subsequent) damages.</p>
	<p>⚠ ATTENTION</p> <p>Return of quick coupling systems that are contaminated with a type of media that is a risk to health.</p> <p>Media that is a risk to health is released during the removal process.</p> <p>► The quick coupling system must be completely clean when returning it to WALTHER-PRÄZISION. The sender (client) is responsible for ensuring this.</p>
	<p>NOTE</p> <p>Use only WALTHER-PRÄZISION original (replacement) parts in order to ensure the operation and maintenance of your quick coupling system. We expressly remind you that we do not offer liability, warranty and service, when (replacement) parts from other manufacturers are used or when combinations are employed which use (replacement) parts from other manufacturers.</p>

5.1 Maintenance

	NOTE
	<p>A maintenance plan must be created and executed by the user. This maintenance plan should contain, at least, the following points, which are to be taken into account and examined in a visual inspection of the quick coupling system.</p> <ul style="list-style-type: none">▶ Check for damaged or corroded components of all types.▶ Leaks from the connection, valve or other components.▶ Broken coupling mounts (especially for breakaway quick closing devices).▶ These points require the immediate replacement or repair of the quick coupling system.

	NOTE
	<p>A maintenance plan must be created and executed by the user. This maintenance plan should contain, at least, the following points which are to be taken into account in a visual inspection of the plant.</p> <ul style="list-style-type: none">▶ Contamination of the exterior or the connection zone of the quick coupling system.▶ Other mounts.▶ Protective mechanisms.▶ Fluid level, fluid characteristics and ventilation of the system.▶ Tension relief▶ Bending radii.

In order to minimise activation forces and to extend the lifetime of the quick coupling system, we recommend lightly greasing the connecting surfaces if this is permitted.

Check all connections for secure connection.

As described under the section called Operating instructions, the quick coupling system is coupled several times, pressure is applied and then it is decoupled.

The coupling and decoupling procedure may only be carried out under the observation of safety instructions and intended use.

The quick coupling system must function perfectly and smoothly and be sealed when coupled and decoupled.

Repairs must be made when faults are determined.

5.1.1 Maintenance of electrical plug inserts

The frequency of electrical plug insert maintenance will depend on a number of factors including, temperature, environmental contamination, usage and plugging cycles.

The contact pins are lubricated with KONTASYNTH BA on delivery in order to reduce wear and improve corrosion protection.

Maintenance should be carried out every 3 months as standard. If necessary it must be carried out more frequently, according to type and frequency of use.

	NOTE
	Only use cleaning media that will not damage the electrical plug inserts! Functional faults may occur otherwise.

The maintenance of electrical plug inserts includes:

- Checking the electrical plug inserts visually for damages.
- Cleaning contacts.
- Checking screw cable connections.
- In every maintenance procedure and after every cleaning procedure, the components must be lubricated with KONTASYNTH BA.
When lubricating, ensure that only the contact pins are coated.
- After cleaning and lubricating, do not touch the contact pins and avoid unnecessary contamination.

5.2 Repairs

Clean the contamination from the functional areas (seal, activation areas) accessible from the outside.

After cleaning and if permitted, lubrication must be applied in order to extend the lifetime of the quick coupling system.

In the event of damaged, cracked or corroded parts, the quick coupling system must be removed, decontaminated and sent to WALTHER-PRÄZISION for repair.

In the event of worn, brittle or over-aged seals as well as serious contamination, it is the decision of the customer whether they wish to send the coupling unit to WALTHER-PRÄZISION or whether they wish to repair it themselves.

The prerequisite for the client-side repair is that the specific operating instructions permit it.

	NOTE
	After repairing, a complete functional test must always be carried out. This may also be completed by means of the working process.

6 Operating

	<p>NOTE</p> <p>Coupling and decoupling must be implemented without pressure. Exceptions must be coordinated with WALTHER-PRÄZISION.</p>
---	---

6.1 Coupling procedure

The two customer structures, fitted with the free half and fixed half, are brought together. This bringing together is executed until the built-in elements form a block (fully coupled state). All movement and reaction forces are absorbed by the customer structure and the customer-side control is triggered.

The alignment of the plates is carried out automatically via the floating position.

During the entire working process, the customer-side control must be secured to ensure that the multiple-coupling remains fully coupled.

6.2 Decoupling procedure

The multicoupling is decoupled by moving the two customer structures apart using the customer-side control.

In doing so, the valves of the built-in elements close automatically.

7 Contact data

WALTHER-PRÄZISION

Carl Kurt Walther GmbH & Co. KG

Westfalenstrasse 2

42781 Haan

Postfach 42 04 44

42404 Haan, Germany

Tel.: +49 (0) 2129 / 567-0

Fax: +49 (0) 2129 / 567-450

Email: info@walther-praezision.de

Internet: www.walther-praezision.de

Contact partner:

Application technology and service

Holger R. Figge

Telephone: +49 (0) 2129 / 567-591

Fax: +49 (0) 2129 / 567-590

Mobile: +49 (0) 162 / 5672090100

Email: hfigge@walther-praezision.de

Any replication, evaluation or communication to unauthorised parties is thus actionable and will be pursued in court (copyright law, fair trade law, BGB - German Civil Code).

All rights reserved for the event of patent grant (paragraph 7, section 1 German Patent Law) or registration of a utility model or design (paragraph 5, section 4 German Utility Model Law)

The copying of documents by clients of WALTHER-PRÄZISION is only permitted for internal company use

WALTHER-PRÄZISION thanks you for your trust in selecting a product from our range.