

	page
Dust caps, Dust plugs	92 - 93
Air blowers	94
Air guns	95
Threaded hose connectors, Revolving connectors	96

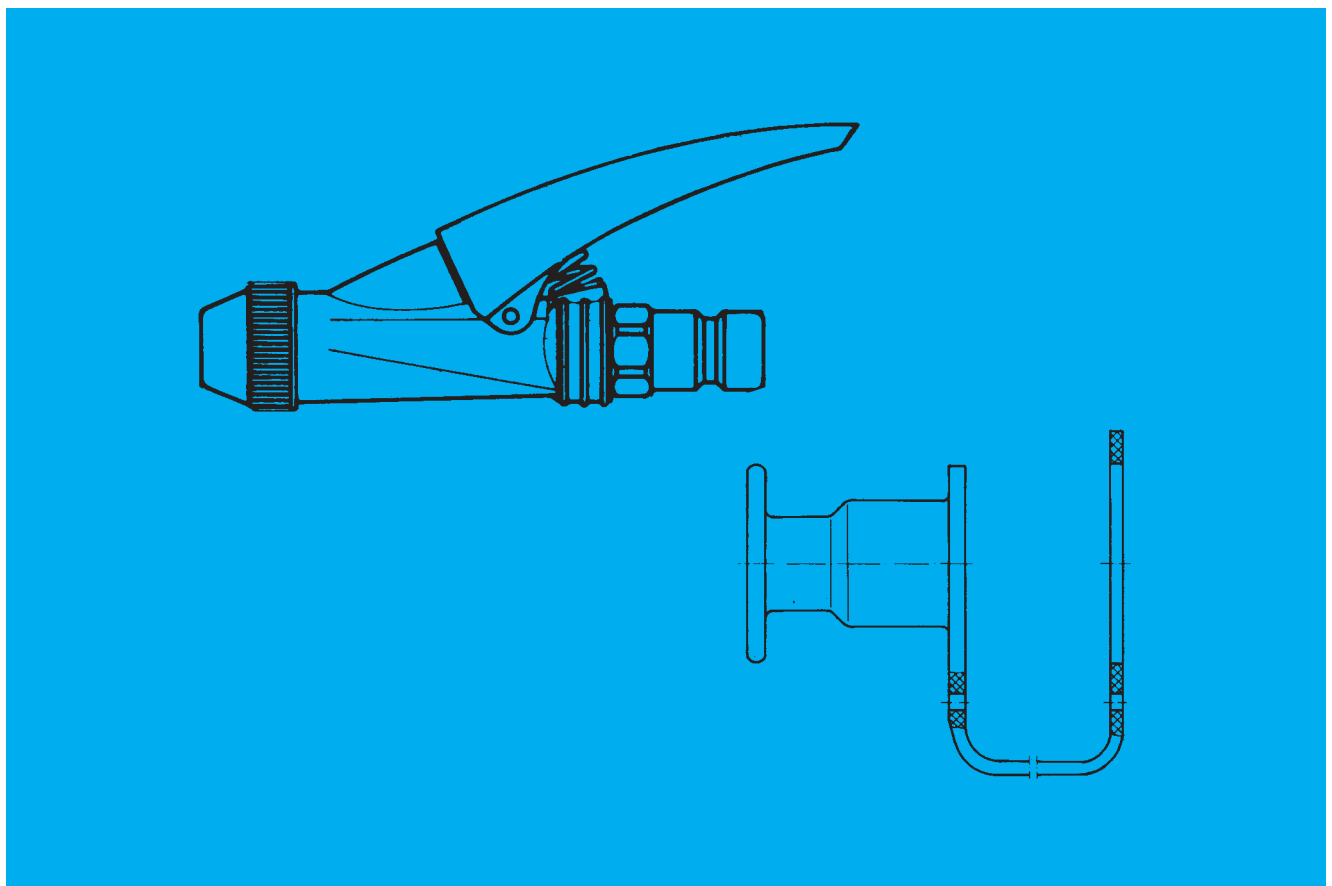

96 Dust caps – Dust plugs

Plastic version

Materials:
Soft-PVC
Polyurethane

Availability: ● Short ○ Medium ○ Long

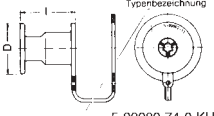
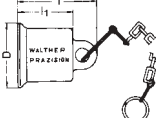
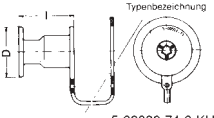
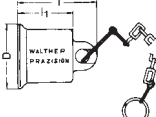
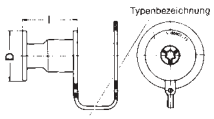
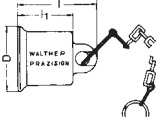
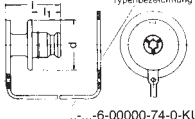
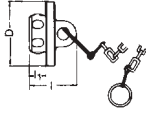
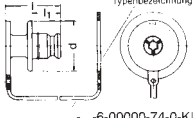
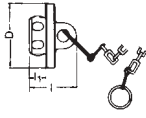
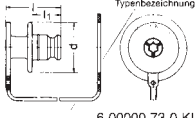
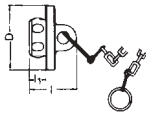
	Materials	For Series / Type			Part No.	d	l	l _i		Weight [g]
		low pressure	medium pressure	high pressure						
Dust caps for self-sealing adaptors and thru types adaptors	 <p>Typenbezeichnung5-00000-74-0-KU</p>	Polyurethane LP/LV-004 soft-PVC grey	LP/LV-004 SP-006 LP-006 LP-007 LP-012 LP-019		LP-004-5-74-KU	18	23		●	4
					SP-006-5-74-KU	22	24		●	5
					LP-006-5-74-KU	22	24		●	5
					LP-007-5-74-KU	25	27		●	7
					LP-012-5-74-KU	32	33,5		●	12
					LP-019-5-74-KU	44	37,5		●	20
	 <p>WÄLTER PRÄZISION</p>	soft-PVC grey chains + rings: steel nickel-plated	SP-009 LP-032 LP-050		SP-009-5-74-KK	25,5	46	31	●	16
					LP-032-5-74-KK	73	76	58	●	65
					LP-050-5-74-KK	114,5	110	92	●	110
Dust caps for self-sealing adaptors and thru types adaptors	 <p>Typenbezeichnung5-00000-74-0-KU</p>	soft-PVC grey		SG-006 MD-006 MD-007 MD-012 MD-019	SP-006-5-74-KU	22	24		●	7
					MD-006-5-74-KU	22	24		●	7
					MD-007-5-74-KU	25	27		●	7
					MD-012-5-74-KU	32	33,5		●	11
					LP-019-5-74-KU	44	37,5		●	20
						 <p>WÄLTER PRÄZISION</p>	soft-PVC grey chains + rings: steel nickel-plated	MD-032 MD-050		LP-032-5-74-KK
LP-050-5-74-KK	114,5	110	92	●						110
Dust caps for self-sealing adaptors and thru types adaptors	 <p>Typenbezeichnung5-00000-73-0-KU</p>	soft-PVC black		HP-004 HP-006 HP-010 HP-016 HP-020	HP-004-5-73-KU	23	27,5		●	7
					HP-006-5-73-KU	30	33		●	11
					HP-010-5-73-KU	34	38		●	16
					HP-016-5-73-KU	41	43		●	20
					HP-020-5-73-KU	45	45		●	25
						 <p>WÄLTER PRÄZISION</p>	soft-PVC grey chains + rings: steel nickel-plated	HP-032 HP-050		HP-032-5-74-KK
HP-050-5-74-KK	114,5	110	92	●						110
Dust plugs for self-sealing couplings and thru type couplings	 <p>Typenbezeichnung6-00000-74-0-KU</p>	Polyurethane soft-PVC grey	LP/LV-004 SP-006 LP-006 LP-007 LP-012 LP-019		LP-004-6-74-KU	18	24	12	●	5
					SP-006-6-74-KU	22	25	13	●	7
					LP-006-6-74-KU	22	30	18	●	8
					LP-007-6-74-KU	25	34	18	●	10
					LP-012-6-74-KU	32	43	23	●	19
					LP-019-6-74-KU	44	46	26	●	34
		soft-PVC grey chains + rings: steel nickel-plated	SP-009 LP-032 LP-050		SP-009-6-74-KK	34	35	19	●	19
					LP-032-6-74-KK	82	60	32	●	160
					LP-050-6-74-KK	112	66	37	●	240
Dust plugs for self-sealing couplings and thru type couplings	 <p>Typenbezeichnung6-00000-74-0-KU</p>	soft-PVC grey		SG-006 MD-006 MD-007 MD-012 MD-019	SP-006-6-74-KU	22	25	13	●	7
					MD-006-6-74-KU	22	30	18	●	8
					MD-007-6-74-KU	25	34	18	●	9
					MD-012-6-74-KU	32	43	23	●	19
					LP-019-6-74-KU	44	46	26	●	34
							soft-PVC grey chains + rings: steel nickel-plated	MD-032 MD-050		LP-032-6-74-KK
LP-050-6-74-KK	112	66	37	●						240
Dust plugs for self-sealing couplings and thru type couplings	 <p>Typenbezeichnung6-00000-73-0-KU</p>	soft-PVC black		HP-004 HP-006 HP-010 HP-016 HP-020	HP-004-6-73-KU	20	27,5	15,5	●	7
					HP-006-6-73-KU	30	33	17	●	13
					HP-010-6-73-KU	34	42	22	●	23
					HP-016-6-73-KU	41	45	25	●	32
					HP-020-6-73-KU	45	47	27	●	40
							soft-PVC grey chains + rings: steel nickel-plated	HP-032 HP-050		HP-032-6-74-KK
HP-050-6-74-KK	112	66	37	●						240

Dust caps – Dust plugs

pressure tight version

Materials:

Dichtungen

- 1 = NBR)
- 2 = FKM
- 4 = EPDM

working pressure:
as matching Type

Standard:

- 11 = steel zinc-plated
- 19 = steel zinc-plated/oil burnished
- 12 = steel oil burnished

Availability: ● Short ○ Medium ○ Long

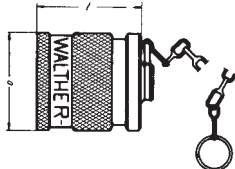
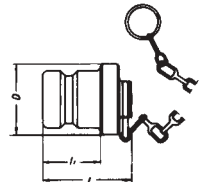
	Materials	For Series / Type			Part No.	d	l	l ₁		Weight [g]	
		low pressure	medium pressure	high pressure							
Dust caps with chain and ring for self-sealing adaptors and thru type adaptors 	steel zinc-plated chains + rings: steel, nickel-plated	SP-006			SP-006-5-11-.	22	38		●	100	
		LP-006			LP-006-5-11-.	25	45		●	120	
		LP-007			LP-007-5-11-.	30	52		●	200	
		LP-012			LP-012-5-11-.	40	58		●	340	
		LP-019			LP-019-5-11-.	54	64		●	610	
		LP-032			LP-032-5-11-.	82	88		●	2150	
		LP-050			LP-050-5-11-.	112	103		●	4400	
	steel zinc-plated/ oil-burnished chains + rings: steel, nickel-plated		MD-006			MD-006-5-19-.	25	45		●	120
			MD-007			MD-007-5-19-.	30	52		●	200
			MD-012			MD-012-5-19-.	40	58		●	350
			MD-019			MD-019-5-19-.	54	64		●	610
			MD-032			MD-032-5-19-.	82	88		●	2150
			MD-050			MD-050-5-19-.	112	103		●	4400
	steel oil-burnished chains + rings: steel, nickel-plated				HP-006	HP-006-5-12-.	34	52		●	250
					HP-010	HP-010-5-12-.	46	60		●	400
					HP-016	HP-016-5-12-.	56	73		●	870
					HP-020	HP-020-5-12-.	62	73		●	1000
					HP-032	HP-032-5-12-.	90	94		●	2650
Dust plugs with chain and ring for self-sealing couplings 	brass passivated	LP-004			LP-004-6-21	18	28	16	●	36	
	steel zinc-plated chains + rings: steel, nickel-plated	SP-006				SP-006-6-11	22	33	20	●	60
		LP-006				LP-006-6-11	25	38	20	●	75
		LP-007				LP-007-6-11	25	38	23,3	●	70
		LP-012				LP-012-6-11	30	44	29,5	●	110
		LP-019				LP-019-6-11	40	50	32,5	●	200
		LP-032				LP-032-6-11	65	58	39	●	580
			LP-050			LP-050-6-11	100	66	46	●	1650
	steel oil-burnished chains + rings: steel, nickel-plated		MD-006			MD-006-6-12	25	38	21,7	●	70
			MD-007			MD-007-6-12	25	38	25	●	60
			MD-012			MD-012-6-12	30	44	31,5	●	95
			MD-019			MD-019-6-12	40	50	35,5	●	200
			MD-032			MD-032-6-12	65	58	41	●	520
			MD-050			MD-050-6-12	100	70	50	●	1630
	steel oil-burnished chains + rings: steel, nickel-plated				HP-006	HP-006-6-12	30	48	30,5	●	100
					HP-010	HP-010-6-12	40	50	36	●	150
					HP-016	HP-016-6-12	40	58	41	●	210
					HP-020	HP-020-6-12	40	60	43	●	250
				HP-032	HP-032-6-12	62	71,5	49,5	●	570	

98 Air Blowers





Blast pipes, nozzles, self-sealing, with lever operation, flexible

Availability: ● Short ○ Medium ○ Long

	Material	Part No.	Connection A	d	l	t		Weight [g]
Hose tailpiece	Polyamide	95001-9-SL009	9 mm	33	153	30	○	180
		95001-9-SL011	11 mm	33	153	30	○	180
		95001-9-SL013	13 mm	33	153	30	●	190
		95001-9-SL016	16 mm	33	158	35	○	220
95001-9-SL019		19 mm	33	158	35	●	220	
		Nozzle size 3 mm, other nozzles of 4 mm, 6 mm and 8 mm available on request						
Hose tailpiece	Brass passivated	95002-9-SL006	6 mm	22	126	25	●	200
		95002-9-SL009	9 mm	22	138	30	●	210
		95002-9-SL011	11 mm	22	138	30	○	220
		95002-9-SL013	13 mm	22	138	30	○	220
		Nozzle size 2 mm, other nozzles of 2,5 mm, 3 mm, 4 mm and 5 mm available on request						
Hose tailpiece	Soft-PVC	95000-9-SL009	9 mm	24	135	30	●	100
		95000-9-SL011	11 mm	24	135	30	○	100
		95000-9-SL013	13 mm	24	135	30	○	110
		Also available with suspension hook						
Thru type adaptor connection	Polyamide	95001-9-ST006	LP-006-1	33	143	20	○	180
		95001-9-ST007	LP-007-1	33	146,5	23,3	○	190
		95001-9-ST012	LP-012-1	33	152,5	29,5	○	220
		Nozzle size 3 mm, other nozzles of 4 mm, 6 mm and 8 mm available on request						
Thru type adaptor connection	Brass passivated	95002-9-ST006	LP-006-1	21	128	20	●	220
		95002-9-ST007	LP-007-1	21	133	23,3	○	230
		Nozzle size 2 mm, other nozzles of 2,5 mm, 3 mm, 4 mm and 5 mm available on request						
Thru type adaptor connection	Soft-PVC	95000-9-ST006	LP-006-1	24	123	20	●	100
		95000-9-ST007	LP-007-1	24	126,5	23,3	○	110
		Also available with suspension hook						

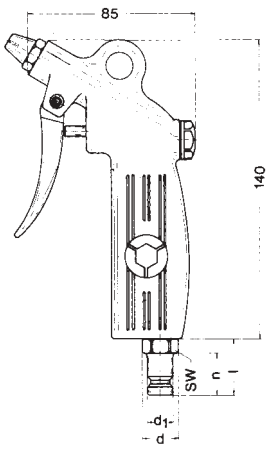
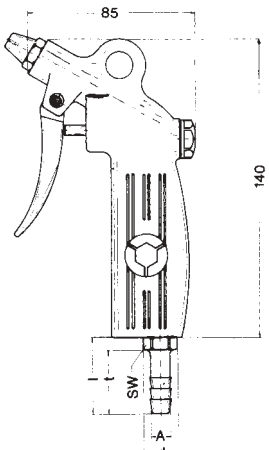
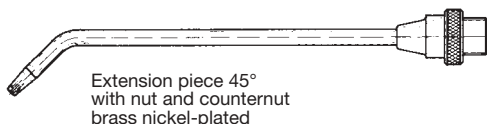
Materials:
 gun body – Aluminium
 nozzle 1,5 mm – brass nickel-plated
 extension piece – brass nickel-plated
 plug connection (thru type adaptor) – steel, hardened, zinc-plated
 hose tailpiece – brass passivated

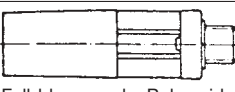
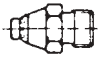
Availability: ● Short ○ Medium ○ Long

	Part No.	Connection A	SW	l	t	n	d	d ₁		Weight [g]
	95003-9-ST006	LP-006-1	14	26		20	15,5	12	●	250
	95003-9-ST007	LP-007-1	17	29,5		23,3	18,9	14	●	260
	95003-9-SL006	6 mm	14	31	25		15,5		●	250
	95003-9-SL009	9 mm	17	36	30		18,5		●	250
	95003-9-SL011	11 mm	17	36	30		18,5		●	260
	95003-9-SL013	13 mm	17	36	30		18,5		●	270
 <p>Extension piece 45° with nut and counter nut brass nickel-plated</p>	95004-9-LG100	100 mm	For better aiming in inaccessible places. Air consumption as regular nozzle.						●	40
	95004-9-LG150	150 mm							●	46
	95004-9-LG250	250 mm							○	60
 <p>Muffling nozzle, Aluminium M 12x1,5</p>	95012	Muffling nozzles reduce noise substantially, without reduction of blowing force. The air consumption is approx. 50% higher than a regular nozzle.							●	6
 <p>Full-blow nozzle, Polyamide</p>	95013	This nozzle increases the quantity of blown air 3 or 4-fold by sucking more air. The full jet is especially suitable for blowing off large areas (e.g. drying). The air consumption is approx. like the muffling nozzle.							●	12
 <p>Nozzle with air jacket, Aluminium</p>	95014	Around the blowing jet a cone-sharper air jacket is located, which prevents recoiling of whirled up particles							●	6
 <p>Protection shield</p>	95015	The protection shield, 70 mm dia, made of plastic, serves as protection for the eyes against recoiling, sharp articles. It is recommended by associations for safety-at-work.							●	9

100 Threaded Hose Connectors

Materials:
 21 = brass passivated
 40 = Polyacetals

Availability: ● Short ● Medium ○ Long

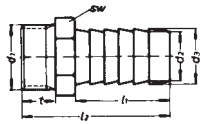
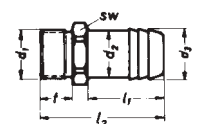
	Part No.	Thread		Hose Tailpiece			Total Length l_2	Hexagon AF	n.b.		Weight [g]
		\varnothing d ₁	Length t	\varnothing d ₂	\varnothing d ₃	Length l ₁					
Threaded Hose Connector  Material: brass passivated	5-AN0-OSL-006-WR010-21	G 1/8 A	8	6	7,5	25	38	11	4	●	10
	5-AN0-OSL-009-WR010-21	G 1/8 A	8	8	9,5	25	38	11	6	●	12
	5-AN0-OSL-006-WR013-21	G 1/4 A	9	6	7,5	25	39	14	4	●	15
	5-AN0-OSL-009-WR013-21	G 1/4 A	9	8	9,5	25	39	14	6	●	19
	5-AN0-OSL-011-WR013-21	G 1/4 A	9	10	11,5	25	39	14	7	●	22
	5-AN0-OSL-013-WR013-21	G 1/4 A	9	13	14,5	30	44	17	10	●	30
	5-AN0-OSL-006-WR017-21	G 3/8 A	9	6	7,5	25	39	17	4	●	21
	5-AN0-OSL-009-WR017-21	G 3/8 A	9	8	9,5	25	39	17	6	●	24
	5-AN0-OSL-011-WR017-21	G 3/8 A	9	10	11,5	25	39	17	7	●	27
	5-AN0-OSL-013-WR017-21	G 3/8 A	9	13	14,2	30	44	17	10	●	29
	5-AN0-OSL-006-WR021-21	G 1/2 A	11	6	7,5	25	42	22	4	●	32
	5-AN0-OSL-009-WR021-21	G 1/2 A	11	8	9,5	25	42	22	6	●	34
	5-AN0-OSL-011-WR021-21	G 1/2 A	11	10	11,5	25	42	22	7	●	39
	5-AN0-OSL-013-WR021-21	G 1/2 A	11	13	14,2	30	47	22	10	●	40
	5-AN0-OSL-016-WR021-21	G 1/2 A	11	16	17,5	30	47	22	12	●	50
Threaded Hose Connector  Material: Polyacetals	5-AN0-OSL-013-WR021-40	G 1/2 A	14,5	13	14	30	52,5	24	8	●	10
	5-AN0-OSL-025-WR048-40	G 1 1/2 A	18	25	27	40	73	50	19	●	19
	5-AN0-OSL-032-WR048-40	G 1 1/2 A	18	32	34	45	78	50	22	●	28
	5-AN0-OSL-038-XX069-40	G 1 1/2 A	18	38	40	61	94	50	28	●	30
	5-AN0-OSL-042-XX004-40	G 1 1/2 A	18	42	45	61	94	50	32	●	33