

Operating instruction English

Revision	C
Date	08.03.2011
Issuer	PPI / NH

This operating instruction is not subject to the updating

Self sealing coupling Medium Pressure Series

1-MD-025-0-.....-..

1-MD-025-2-.....-..

1-MD-050-0-.....-..

1-MD-050-2-.....-..

optional features:

OV SI GG EX

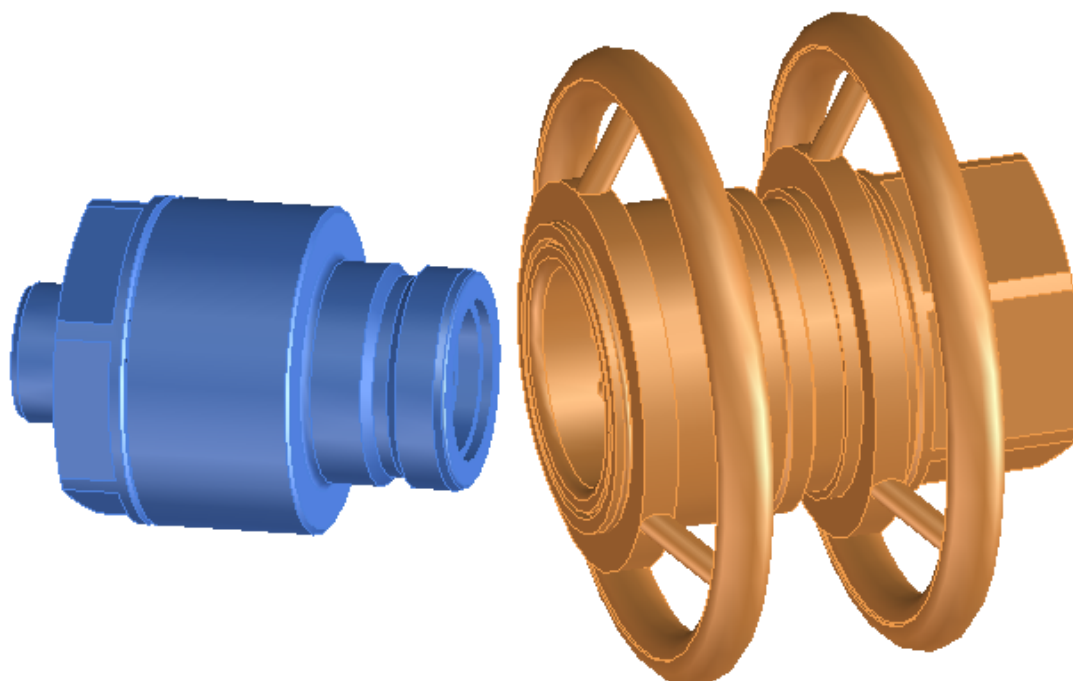

Vor Beginn aller Arbeiten
Betriebsanleitung lesen!

*Read operating instruction
before beginning of all works!*

Betriebsanleitung immer
AUFBEWAHREN!
griffbereit am Gerät

*Always KEEP operating
instruction! In a ready hand
way at the device*

Achtung: Vor Inbetriebnahme
Gerät auf mängelfreien Zustand
und technisch einwandfreie
Funktion kontrollieren.

*Caution: Before starting-up
check device on faultless
condition and technically
perfect function.*

Das Original ist die
deutsche Fassung

*The German version
is the original*

This coupling is a quality product, in which special attention has been paid to high functionality, ease of operation, safety and reliability. As an item of technical equipment this coupling is intended for use in the commercial, industrial area and for operators, who have been trained by specialists in the handling of technical systems / tools.

Customer care:

As part of our individual customer care we will be happy to assist you in questions relating to use and operation and on any problems encountered.

Service and maintenance:

In order to maintain the high technical performance capability and reliability of your coupling over many years, we recommend regular inspection and maintenance.

We can thereby offer you optimum support by our Customer Service department and the conclusion of a service and maintenance contract. Please ask for a quotation.

Carl Kurt Walther GmbH & Co. KG
PO Box 42 04 44
42781 Haan
Westfalenstraße 2

Tel.: +49 (0) 2129 567-0
Fax: +49 (0) 2129 567 450

E-Mail: info@walther-precision.de
Internet: www.walther-precision.de

Contact:

Application technology and service

Holger R. Figge
Telephone: (02129) 567-591
Telefax: (02129) 567-590
Handy: (0162) 2090100
e-mail: hfigge@walther-precision.de

Further addresses and telephone numbers of contacts can be found on the Internet on our homepage under www.walther-precision.de "Service / Customer service".

List of Contents

1	<u>List of Contents</u>	
1	LIST OF CONTENTS	3
2	GENERAL	4
3	WARRANTY	5
4	SAFETY INSTRUCTIONS	6
5	PRODUCT DESCRIPTION OF THE SELF SEALING COUPLING	7
5.1	INTENDED USE	7
5.2	TECHNICAL DATA	7
5.3	OPTIONAL FEATURES	8
5.4	EXTENDED PRODUCT DESCRIPTION FOR APPLICATION ACC. TO ATEX-GUIDE LINE 94/9/EG (SPECIAL DESIGN EX):	9
5.4.1	<i>General</i>	9
5.4.2	<i>Extended marking</i>	9
6	INSTALLATION INSTRUCTION	10
6.1	GENERAL	10
6.2	EXTENDED INSTALLATION INSTRUCTION FOR APPLICATION ACC. TO ATEX-GUIDELINE 94/9/EG	11
6.2.1	<i>Details for safe operation</i>	11
6.2.2	<i>Details for safe installation</i>	11
6.2.3	<i>Details for a safe application area</i>	11
7	OPERATING INSTRUCTION	12
7.1	CONNECTION PROCESS	12
7.2	DISCONNECTION PROCESS	13
7.3	SAFETY LOCKING DEVICE SI (SUPPLEMENTARY EQUIPMENT)	13
7.3.1	<i>Coupling process</i>	13
7.3.2	<i>Decoupling process</i>	13
8	MAINTENANCE INSTRUCTION	14
8.1	MAINTENANCE AND FUNCTIONAL TEST	14
8.1.1	<i>Maintenance includes following items:</i>	14
8.1.2	<i>Functional test includes following items:</i>	14
9	TEST	15
9.1.1	<i>Steel / stainless steel</i>	15
9.1.2	<i>Brass, aluminium</i>	16
10	LUBRICATION !	17
11	STORAGE	18
12	SHUT-DOWN	19
13	ORDER NUMBER CODE	20
14	INDEX	21

2 General

This manual contains all regulations for operation, commissioning and maintenance of the self sealing coupling elements.

All information and notes in this operating manual were collated while taking into consideration the valid regulations, the current engineering related status of development as well as our many years of experience and acquired knowledge.

Translations of this operating manual were also produced according to the best of knowledge. However, we cannot assume liability for any translation errors. The German version provided for this operating manual is considered the authoritative version.

The actual scope of delivery can deviate from the explanations and graphic representations described herein under certain circumstances, e.g. in the case of special designs, utilization of additional order options or because of state-of-the-art technical alterations.

If you have any questions, please contact the manufacturer.



This operating manual must be read carefully before starting work on or with the equipment, in particular before commissioning!

The manufacturer assumes no liability for damage or faults arising from non-compliance with the instructions in this operating manual.

The operating manual must be kept directly with the equipment and be accessible to all persons who work on or with the equipment.

It is not permitted for the operating manual to be passed to third parties and if applicable this will incur damage compensation.

All other rights reserved.

Before commissioning the device must be checked for being not defective and its technically perfect function.

The German version is the original.

We reserve the right to make technical alterations to the product within the context of improving the usage properties and further development.

The operating manual remains our property.

Any reproduction, use by or communication to third parties incurs a penalty and will be pursued by court action (copyright law against unfair competition, BGB [German Civil Code]).

All rights reserved in the case of a patent award (Paragraph 7, Section. 1 of the patent law - PG) or entry as a patented design (Paragraph 5, Section 4 of the patented design law - GMG).

3 Warranty

The warranty conforms to:

the "General Conditions for Delivery and Capacity" of C.K. Walther GmbH & Co. KG of the state which was valid at the date of the purchase contract and

the regulations agreed in the purchase contract.

Wearing parts are generally excluded from the warranty.

Typical wearing parts of products from company C.K. Walther GmbH & Co. KG are for example:

- seals
- springs

Safety instructions

4 Safety instructions

Using these couplings does not release the customer from his obligation to comply with the pertinent work safety regulations e.g. operational safety ordinances, etc. The duty to take due care by the operator of the couplings includes planning measures to ensure proper operation and monitoring their implementation.

Hazard notes

If the wrong product has been selected or if there is improper use or maintenance has been omitted, then hazards arise and personal injuries and material damage can occur from:

- Hazardous emission of fluid or individual particles/coupling parts
- Function impairments of connected systems or tools
- The metal parts of coupling and adaptor are not thermally protected. You can be burned if you touch these parts at high media temperatures. According to the ambient temperature valve lever and ring grip can also become unbearably hot. For that reason suitable, sufficiently long protective gloves should be worn.

The operator must in particular make sure that

- The couplings are only used according to the intended purpose.
- The couplings are only operated in a perfect, functioning condition.
- The operating manual is always in a legible condition and is available in its entirety to operating personnel.
- The operating personnel are sufficiently acquainted with the working method and the safety notes for the coupling.
- The coupling is sent to our factory for repair work.
- During operation of the coupling, no safety devices are removed and/or deactivated.
- Before installing or dismantling the coupling, you have made sure that the coupling has not been pressurized.

After completing assembly and installation work and before commissioning the coupling, observe the following points:

Check once again that all screw connections are securely fitted.

Before commissioning the coupling, a function test must be carried out (see maintenance and function test).

Product description of the self sealing coupling

5 Product description of the self sealing coupling

Coupling connection consists of:

- self sealing coupling 1-MD-025-0-.....-..
- self sealing adaptor 1-MD-025-2-.....-..
- self sealing coupling 1-MD-050-0-.....-..
- self sealing adaptor 1-MD-050-2-.....-..

In case that both coupling halves are not connected they should be protected against external dirt and/or damages if required.

For that purpose dust cap and dust plug are available.

Possible combinations :

- self sealing coupling 1-MD-...-0
- with
- dust plug 1-MD-...-6
- self sealing adaptor 1-MD-...-2
- with
- dust cap 1-MD-...-5

5.1 Intended use

- Coupling is only used as connection of two lines.
- Connection and disconnection process is carried out by hand.
- Coupling is especially suitable for the following media/applications:
 - air
 - water
 - hydraulic oil
 - and their subspecies
(such as oxygen or oil with additives)
- For all other possible applications, Walther-Präzision should be consulted.

5.2 Technical data

- Working pressures of coupling depend on materials of individual parts.
- When determining the working with standardized threaded connections, the highest permissible working pressure of the connection must be taken into account.
- When selecting a suitable connection the following static pressure is possible:

	max. static Working pressure steel (bar)	max. static Working pressure brass (bar)	max. static Working pressure st. st. (bar)	Cv-value
MD-025	220	40	50	13
MD-050	100	30	30	59

Product description of the self sealing coupling

- The coupling is not determined for any types of use and technical values other than those listed here.
- Safe operation is not guaranteed if the coupling is used contrary to its intended use and technical values
- The operator of the coupling is responsible for all personal injuries or material damage that occur from non-intended use and disregard of the technical values; the manufacturer assumes no responsibility in these cases.

5.3 Optional Features

OV = without valve (z.B.: 1-MD-...-0-.....-...-OV
1-MD-...-2-.....-...-OV)

SI = with protection by safety locking device (see point 5)
(z.B.: 1-MD-...-0-.....-...-SI)

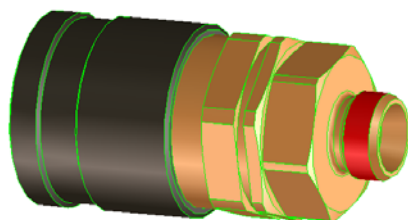

without SI

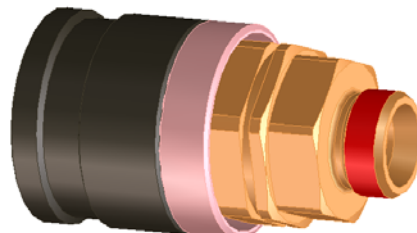

with SI

GG = with ring grips (aluminium cast)
(z.B.: 1-MD-...-0-.....-...-GG)



EX = ATEX – version

Product description of the self sealing coupling

5.4 Extended product description for application acc. to ATEX-guide line 94/9/EG (special design EX):

5.4.1 General

Only non-sparkling materials may be used.
Non-sparkling materials are 1.4305 or equivalent materials.
Furthermore brass with different surfaces (f. ex. chrome-plated, nickel-plated).

Further on it must be assured that the seal is resistant against and suitable for the flowing through media. Also the temperature resistance of the seals must be guaranteed. This must also be considered for the marking acc. to chapter 5.5.2.

5.4.2 Extended marking

The coupling fittings are marked with



As the surface temperature of the self-sealing couplings are determined by the temperature of the fluids, the temperature category or the highest surface temperature must be specified by the operator while the safe temperature distances acc. to EN 13463-1 must be observed and the maximum temperature resistance of the coupling materials and seals are taken into consideration.

The marking of the temperature class must be effected readily visible by the operator.

The determination of the temperature class must be made acc. to the following table:

Max. temperature of fluids	Temperature class
75	T6
90	T5
130	T4
195	T3
295	T2
445	T1

The couplings are not admitted for the temperature classes T1 and T2 and may not be marked for that by the operator.

Installation instruction

6 Installation Instruction

6.1 General

Install the self sealing coupling into the network in due consideration of the general accident prevention regulations, so that:

- an error-free operation according to the operating instructions is guaranteed. Please make sure that you use only the hexagon on the connection which is provided by the customer to tighten or release the coupling / adaptor when assembling or dismantling it (see picture).

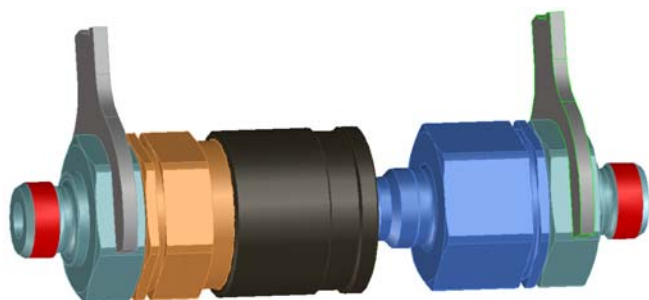
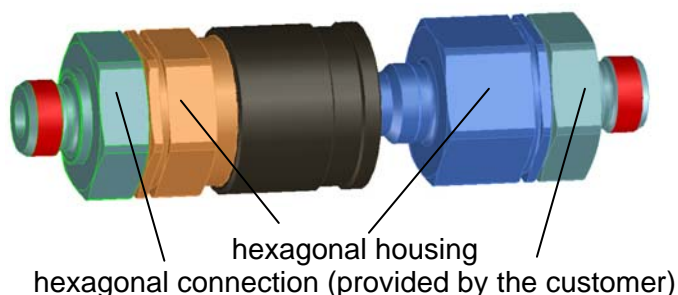

right

wrong

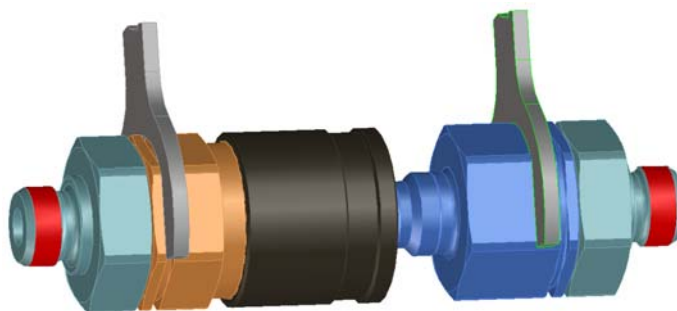

- the screw connection on the connection side (provided by the customer) is made according to the relevant technical regulations.
- the self sealing coupling is predominantly used on the network side and the self sealing coupling is mainly used on the consumer side.
- exterior damage to the unit and to all movable parts is ruled out.

Before installing the through type coupling and the adaptor to the piping system, make sure that the piping system has been sufficiently flushed/blown or cleaned.



After completing the installation work, perform a function test both depressurised and under working pressure, as described in the operating instructions.

Installation instruction

6.2 Extended installation instruction for application acc. to ATEX-guideline 94/9/EG

6.2.1 Details for safe operation

For the use of self sealing couplings as a hose connection it must be guaranteed that in case of pressure strikes the tumbling of the self sealing coupling can be avoided by fixing at suitable constructions. In principle it must be observed that the self sealing coupling cannot strike on hard objects which could produce strike sparks when touching the housing.

6.2.2 Details for safe installation

The self sealing couplings may only be connected to pipe- and hose systems which are suitable for electrostatic discharge and which are connected to the ground potential.

6.2.3 Details for a safe application area

The self sealing couplings may be used according to the class of devices² in areas susceptible to explosions where potentially explosive mixtures of gas, steam, mist and air are available.

Operating instruction

7 Operating Instruction

In order to avoid critical injuries of the staff and damage at the self sealing coupling during operation, coupling may be only used for the stated applications.

7.1 Connection process

Before every couple cycle a visual check of coupling and adaptor is to be carried out. In case of recognizable, visible damage or deformations damaged parts are to be exchanged.

Hold self sealing coupling firmly in one hand; with the other hand pull back locking sleeve. This has to be done against locking spring resistance.

If ring grips are available (optional), the self sealing coupling (free half) at the hose is taken as described in the following picture and the locking sleeve is pulled back at the front ring with the fingers.

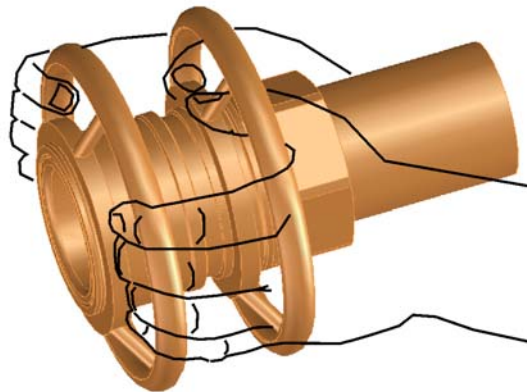

Push free half (coupling) with withdrawn locking sleeve axially centered onto plug part of fixed half (adaptor) until sensible resistance.

Bring locking sleeve with support of locking spring into starting position.

Self sealing coupling and self sealing adaptor are now mechanically locked.



CAUTION

Please take care that locking sleeve is in final position, i.e. that it is flush in front with the coupling housing as otherwise no perfect lock is guaranteed.

Operating instruction

7.2 Disconnection process

Withdraw locking sleeve against locking spring and take out coupling from self sealing adaptor.

Caution!

In case of an available pressure in the line connected by the coupling system a strong separation impulse - depending on the pressure - can be effective onto the coupling system during disconnection. For that reason the movable part of the coupling (free half) is to be firmly held in the hand to avoid injuries.

7.3 Safety locking device SI (supplementary equipment)

7.3.1 Coupling process

For coupling the locking ring must be in unsecured position (picture 2). Coupling as described under 7.1.

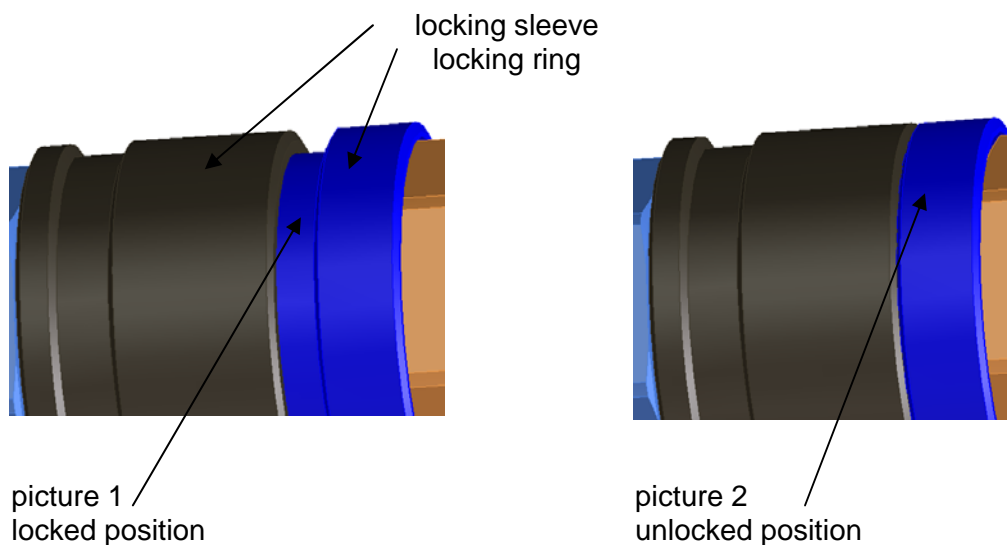

After coupling the locking ring is drawn towards the hose, turned by 90° and released. Now the locking ring snaps forward into the safety position (picture 1).

Both final positions – secured and unsecured – are fixed by spring loaded cams.

The operator can assure himself of the proper locking and saving by trying, as a control, to disconnect the coupling by drawing back the locking sleeve. This is not possible in secured position.

7.3.2 Decoupling process

In coupled situation the locking ring is in secured position (picture 1).

For de-blocking the locking ring is drawn towards the hose, turned by 90° and released.

Now the locking ring snaps forward into the safety position (picture 1).

Both final positions – secured and unsecured – are fixed by spring loaded cams.

Decoupling as described under 7.2.

Maintenance and Functional instruction

8 Maintenance Instruction

Preventive maintenance measures

WALTHER self sealing couplings are to be operated in such a manner that external damages to elements and all moving parts are avoided.

8.1 Maintenance and functional test

In order to always guarantee function of the self sealing coupling and hence safety of operator, a maintenance and functional testing must be made in appropriate periods of time depending on operating conditions.

In order to minimize operating forces and to extend service life of the self sealing coupling we recommend to slightly grease plug surfaces (see item 10.0).

8.1.1 Maintenance includes following items:

- A visual inspection of self sealing coupling and self sealing adaptor regarding damage and contamination has to be made.
- Dirt at the functional area (sealing area, operating elements) which is easily accessible from outside should be removed by simply wiping-off.

If there are damaged, torn or corroded parts, coupling must be dismantled and returned to manufacturer for repair.

If worn or embrittled seals are found or if there is extreme dirt, the customer can decide whether he returns coupling unit to the manufacturer's factory or whether he repairs himself.

8.1.2 Functional test includes following items:

As described in the operating instruction, coupling is several times connected, pressurized and then disconnected.

In doing so, the following has to be observed:

- Connection and disconnection process must be absolutely smooth.
- Coupling must be absolutely leak-proof in connected and disconnected state.

If there are damaged, torn or corroded parts, coupling must be dismantled and returned to manufacturer for repair.

If worn or embrittled seals are found or if there is extreme dirt, the customer can decide whether he returns the coupling unit to the manufacturer's factory or whether he repairs himself.

Please note !

If the coupling is repaired by the customer themselves, a pressure and/or leak test must be performed in any case.

The sequence and extent of this test is described in section "Test".

Please note !

The manufacturer's warranty shall not apply to the end product if it is repaired by other than the manufacturer, Walther-Präzision.

9 Test

These leak tests must be performed according to the following specifications.

9.1.1 Steel / stainless steel

(Extract from the test instructions QM-PA 3.0 of the Walther-Präzision QM system)

- Description:

The coupling is pressure tested according to the following values.

Series medium pressure	bronzed steel
MD-025	290 bar
MD-050	130 bar

The pressure details charted above are only valid for the end fittings stated in the Walther Technical Catalogue.

Other end fittings (e.g. SL connections) have to be tested according to the state of the art.

If the material is steel, the test must be performed on an oil test stand.

If the material is stainless steel, the test must be performed on a water test stand.

In case of EPDM seals, please use the water test stand.

Attention:

Do not test EPDM seals with oil.

- Test setup and test procedure

Test 1: self sealing coupling and
self sealing adaptor connected

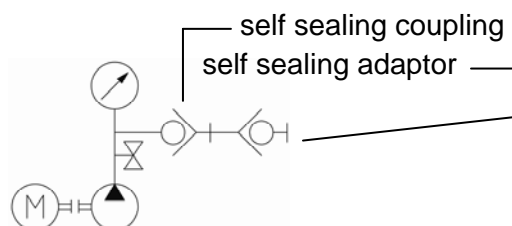

Test 2: self sealing coupling disconnected

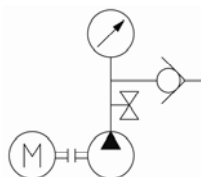

Test 3: self sealing adaptor disconnected

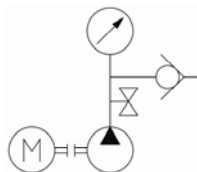

- Notes and remarks:

The dwell time per test is 10 seconds.

During the 10 seconds dwell time there must not be any visible leaks.

Remove the test medium after testing, e.g. by blowing it out.

- Documentation:

Please document the test pressure, test medium and name/date of each test.

9.1.2 Brass, aluminium

(Extract from the test instructions QM-PA 2.0 of the Walther-Präzision QM system)

Description:

The coupling is tested by means of an immersion test according to the following values.

Series medium pressure	passivated brass	Stainless Steel	anodised aluminium
MD-025	1,5 bar absolut	1,5 bar absolut	1,5 bar absolut
MD-050	1,5 bar absolut	1,5 bar absolut	1,5 bar absolut

- Test setup and test procedure

Test 1: self sealing coupling and
 self sealing adaptor connected

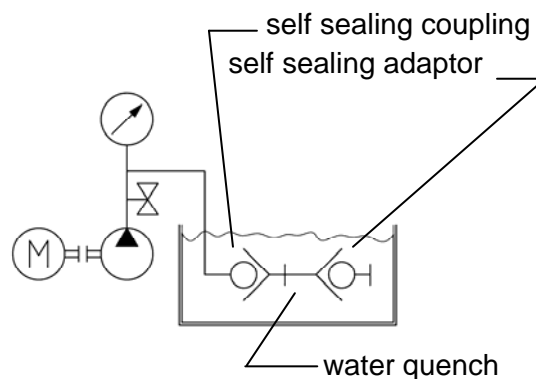

Test 2: self sealing adaptor disconnected

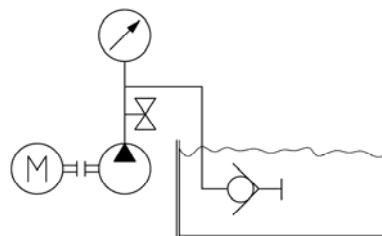

Test 3: self sealing adaptor disconnected

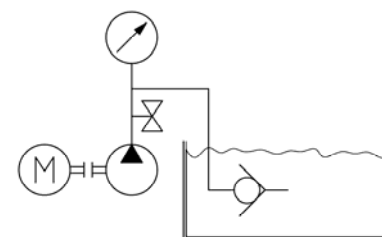

- Notes and remarks:

The dwell time per test is 10 seconds.

There must not be any bubbles during the 10 seconds dwell time.

After testing the coupling must be dried with hot air as soon as possible

(recommended: 45 – 55 °C, approx. 30 min with air stream, up to 2 hours with stagnant air, depending on the device).

- Documentation:

Please document the test pressure, test medium and name/date of each test.

10 Lubrication !

In order to minimize operating forces and to extend service life of the coupling we recommend to slightly grease plug surfaces.

Lubrication is to be carried out with greases which **do not** tend to become resin.



Caution !

The selection of the grease is to be suited to the sealing quality and the medium (e.g.: oxygen) in view of the compatibility.

11 Storage

The couplings must be stored in such a way that no damages can occur at the couplings.

The storage conditions of the couplings must comply with the guidelines for the seals as these can change in properties due to improper storage.

The following items must be kept:

- The couplings must be stored dry.
- To safely conserve the seals and that means also the couplings they should not be stored under the effect of daylight.
- For protection against oxygen the seals and also the couplings shall be stored into the packing.

12 Shut-down

At the end of the service life the coupling or its components have to be disposed non-polluting and according to the legal regulations.

For that the local public or private disposal societies should be taken.

13 Order number code

1.	2.	3.	4.	5.	6.	7.	8.	9.
□	□□	□□□	□	□□□□□	□□	□	□□□	□□
□	□□	□□□	□	□□□□□	□□□□	□	□□□	□□

1. Subject group
2. Series
Series description consists of either two letters or two digits.
3. Nominal size / nominal width
It is rounded up or rounded down to full units.
The indication can be numerical or alphanumeric.
4. Type of product and design
5. Type of connection
6. Material:
xx-x and xxxx possible
7. Material (seal version):
xx-x and xxxx possible
8. Y- or Z-design
9. Optional features

14 Index

<i>A</i>		hydraulic oil	7
According to intended purpose.....	6	<i>I</i>	
Acquired knowledge.....	4	Implementation	6
Adaptorl.....	6	Improvement	4
air.....	7	Index.....	21
Alterations	4	Inspection	2
Assembly	6	Installation Instruction	10
<i>C</i>		Intended use	7
Commissioning.....	4, 6	<i>K</i>	
connected.....	7	Kennzeichnung.....	9
connection	7, 20	<i>L</i>	
Connection process	12	Legible condition	6
coupling.....	4	Liability.....	4
Coupling.....	6, 8, 19	List of Contents	3
Couplings	6	Lubrication	17
Customer care.....	2	<i>M</i>	
<i>D</i>		Maintenance	2, 4, 6
Damage.....	4, 6	Maintenance and functional test.....	14
Damage compensation	4	Maintenance Instruction.....	14
daylight.....	18	Manual	4
Disconnection process	13	Media temperatures	6
Disposal societies	19	Medium Pressure Series.....	1
Disregard	8	<i>O</i>	
dry.....	18	Operating instruction.....	1
dust cap.....	7	Operating Instruction	12
dust plug.....	7	Operation.....	2
<i>E</i>		Operational safety ordinances	6
EPDM seals	15	operator	6, 14
Equipment	4	Operators.....	2
Experience	4	original	4
<i>F</i>		<i>P</i>	
Faults	4	packing	18
Fluid	6	particular	6
Function.....	6	Perfect, functioning condition.....	6
Function test	6	Performance capability.....	2
Functionality.....	2	Pressurized	6
<i>G</i>		Product description	7
General	4	Property	4
guarantee	14	Protective gloves	6
<i>H</i>		<i>Q</i>	
Hazard notes	6	quality.....	17
Hazardous emission.....	6	questions.....	4

<i>R</i>		
Regulations	4	
Reliability	2	
remarks	15, 16	
Repair work	6	
responsible	8	
<i>S</i>		
Safety	2	
Safety devices	6	
Safety instructions	6	
Scope of delivery	4	
Screw connections	6	
self sealing adaptor	7, 12, 13, 14	
self sealing coupling	7, 12, 14	
Self sealing coupling	1, 12	
service	14, 17	
Service	2	
Shut-down	19	
Special designs	4	
Specialists	2	
specifications	15	
Status of development	4	
Storage	18	
subspecies	7	
		Systems
		2, 6
		<i>T</i>
		Technical data
		7
		Technical equipment
		2
		Technical values
		8
		Temperaturbeständigkeit
		9
		Temperaturklasse
		9
		Test
		15, 16
		Thermally
		6
		Tools
		2, 6
		Translation errors
		4
		Types of use
		8
		<i>U</i>
		Use
		2
		<i>V</i>
		Version
		4
		<i>W</i>
		water
		7
		Work safety regulations
		6
		Working method
		6
		working pressure
		7
		Wrong product selection
		6